THE VILLAGE OF TINLEY PARK

Cook County, Illinois

Will County, Illinois

**ORDINANCE
NO. 2020-O-066**

**AN ORDINANCE OF THE VILLAGE OF TINLEY PARK, COOK AND WILL COUNTIES, ILLINOIS,
AMENDING CERTAIN PROVISIONS OF THE LONG TERM WATER SALE, PURCHASE AND
SERVICE AGREEMENT BY AND AMONG THE VILLAGE OF OAK LAWN, COOK COUNTY,
ILLINOIS, AND OTHER MUNICIPALITIES, AND AUTHORIZING THE EXECUTION AND
DELIVERY OF SAID AMENDMENT**

**JACOB C. VANDENBERG, PRESIDENT
KRISTIN A. THIRION, VILLAGE CLERK**

**CYNTHIA A. BERG
WILLIAM P. BRADY
WILLIAM A. BRENNAN
DIANE M. GALANTE
MICHAEL W. GLOTZ
MICHAEL G. MUELLER
Board of Trustees**

Published in pamphlet form by authority of the President and Board of Trustees of the Village of Tinley Park

VILLAGE OF TINLEY PARK

Cook County, Illinois

Will County, Illinois

ORDINANCE NO. 2020-O-066

AN ORDINANCE OF THE VILLAGE OF TINLEY PARK, COOK AND WILL COUNTIES, ILLINOIS, AMENDING CERTAIN PROVISIONS OF THE LONG TERM WATER SALE, PURCHASE AND SERVICE AGREEMENT BY AND AMONG THE VILLAGE OF OAK LAWN, COOK COUNTY, ILLINOIS, AND OTHER MUNICIPALITIES, AND AUTHORIZING THE EXECUTION AND DELIVERY OF SAID AMENDMENT

WHEREAS, the Village of Tinley Park, Cook and Will Counties, Illinois (the “Village”) on the 3rd day of December, 2013, and on the 1st day of July, 2014, adopted Ordinance No. 2013-O-055 and Ordinance No. 2014-O-011, respectively (the “Ordinances”), authorizing the execution and delivery of a “Water Sale, Purchase and Service Agreement Between the Village of Oak Lawn, Illinois and Certain of Its Municipal Customers,” dated August 1, 2014 (the “Agreement”); and

WHEREAS, the President and Board of Trustees of the Village (the “Corporate Authorities”) have determined and do hereby determine that that it is necessary and in the best interests of the Village that certain provisions of the Agreement be amended and that such Amendment and said Agreement so amended be authorized to be executed and delivered as herein provided; and

WHEREAS, the form of the First Amendment to the Water Sale, Purchase and Service Agreement between the Village and the Southwest System Customers (the “Southwest System First Amendment”) has been presented to the Corporate Authorities and is attached hereto as Attachment A:

NOW, THEREFORE, BE IT ORDAINED BY THE PRESIDENT AND BOARD OF TRUSTEES OF THE VILLAGE OF TINLEY PARK, COOK AND WILL COUNTIES, ILLINOIS, AS FOLLOWS:

Section 1. Incorporation of Preambles. The findings and determinations set forth in the preambles to this Ordinance are hereby made findings and determinations of the Corporate Authorities of the Village and are incorporated into the body of this Ordinance by reference.

Section 2. Ratification, Approval and Incorporation of Amendment. The Agreement as approved by the Ordinances is hereby ratified, confirmed and approved, subject to the Southwest System First Amendment as hereby approved (the “Amended Southwest System Agreement”). The Village is authorized pursuant to this Ordinance to be bound by the terms and conditions of the Southwest System First Amendment. The Southwest System First Amendment and the Agreement shall be read together as one document. The Village Clerk is hereby authorized to replace the provisions of the Agreement with the amendments as approved herein.

Section 3. Execution. By this Ordinance, the President of the Village is hereby authorized and directed to execute and deliver and the Village Clerk is hereby authorized to attest and seal the Southwest System First Amendment and the Amended Southwest System Agreement.

Section 4. Publication. A full, true and complete copy of this Ordinance shall be published within ten days after passage in pamphlet form by authority of the Corporate Authorities.

Section 5. Severability; Superseder. If any section, paragraph, clause or provision of this Ordinance shall be held invalid, the invalidity of such section, paragraph, clause or provision shall not affect any of the other provisions of this Ordinance. All ordinances, resolutions and orders, or parts thereof, in conflict with this Ordinance are hereby superseded to the extent of such conflict and as further provided in the Agreement as Amended.

Section 6. Effective Date. This Ordinance shall be in full force and effect immediately upon its passage, approval and publication.

PASSED THIS 20th day of October, 2020.

AYES: Berg, Brady, Brennan, Galante, Glotz, Mueller

NAYS: None

ABSENT: None

APPROVED THIS 20th day of October, 2020.

ATTEST: 

VILLAGE CLERK



VILLAGE PRESIDENT

ATTACHMENT 1

SOUTHWEST SYSTEM FIRST AMENDMENT

Southwest System Customers

**FIRST AMENDED AND RESTATED
•REGIONAL WATER SYSTEM•
WATER SALE, PURCHASE AND SERVICE AGREEMENT
BETWEEN THE VILLAGE OF OAK LAWN, ILLINOIS AND
CERTAIN OF ITS MUNICIPAL CUSTOMERS**

**FIRST AMENDED AND RESTATED
•REGIONAL WATER SYSTEM•
WATER SALE, PURCHASE AND SERVICE AGREEMENT
BETWEEN THE VILLAGE OF OAK LAWN, ILLINOIS AND
CERTAIN OF ITS MUNICIPAL CUSTOMERS**

BETWEEN

THE VILLAGE OF OAK LAWN, ILLINOIS

AND

VILLAGE OF MOKENA
VILLAGE OF NEW LENOX
CITY OF OAK FOREST

VILLAGE OF ORLAND PARK
VILLAGE OF TINLEY PARK

Originally Dated: August 1, 2014
Amended: November 1, 2020

TABLE OF CONTENTS

SECTION	HEADING	PAGE
PREAMBLES		1
SECTION 1.	RECITALS AND DEFINITIONS	5
	A. Recitals	5
	B. Definitions	5
SECTION 2.	OAK LAWN TO SERVE AND MUNICIPAL CUSTOMERS TO TAKE	17
	A. Basic Duties	17
	B. Nature of Payment Obligation; Take or Pay Obligation	17
SECTION 3.	CONDITIONS PRECEDENT AND SUBSEQUENT	17
SECTION 4.	BONDS; FINANCE	18
	A. Regional System Revenue Bonds	18
	B. Plan of Finance and Issuance of New Series Bonds for Purposes of 2013 Regional System Improvements	18
	C. Issuance of New Series Bonds for Refunding Purposes	19
	D. Plan of Finance; Issuance of Future Series Bonds for Non-Refunding Purposes	19
	E. Issuance of Future Series Bonds for Refunding Purposes	20
	F. Cash Contributions	21
	G. Other System Project and Related Financing Permitted	22
SECTION 5.	LIMITATION OF USE OF OAK LAWN REGIONAL WATER SYSTEM	22
SECTION 6.	WATER SUPPLY	22
	A. Serve and Purchase Full Water Requirements; Exceptions	22
	B. Continuous Water Supply	23
	C. Delivery of Additional Water	23
	D. Curtailment	24
	E. Pressure at Delivery	24
	F. Certain Water Quality Provisions	24
SECTION 7.	CERTAIN PERMITTED SERVICE AND CONNECTIONS	25
	A. Municipal Customer Service and Connections Generally	25
	B. Wholesale Service and Connections Recognized	25
	C. Oak Lawn Service and Connections	25
	D. Emergency Customers	26
	E. Other Service by Amendment	26

SECTION 8.	CERTAIN MUTUAL STORAGE, OPERATION AND CONSERVATION PROVISIONS; ASSET MANAGEMENT PROGRAM; CERTAIN SYSTEM PROJECT AND RELATED FINANCING PERMITTED.....	26
	A. Municipal Customer Storage Requirements.....	26
	B. Operation of Municipal Customer Water Systems.....	26
	C. Notice in Certain Events Regarding Water Supply.....	27
	D. Conservation.....	27
	E. In General—Operation of Oak Lawn Regional Water System.....	27
	F. Asset Management and Asset Management Program.....	28
SECTION 9.	MEASURING EQUIPMENT.....	28
	A. Measuring Supply to Municipal Customers.....	28
	B. Annual Calibration.....	29
	C. Check Meters.....	29
	D. Variance.....	29
	E. Notice of Testing and Calibration.....	30
	F. Unit of Measurement.....	30
	G. Meter Malfunctions.....	30
SECTION 10.	OWNERSHIP.....	30
	A. Title to Chicago Water.....	30
	B. Oak Lawn Ownership.....	30
SECTION 11.	TRANSFER OF PROPERTY RIGHTS.....	31
	A. Conveyance of Southwest Customer Easements.....	31
	B. Acquisition of Property.....	31
	C. License to Use the Orland Spur One Main.....	32
	D. Conveyance of and License to Use the Orland Spur Two Main.....	32
	E. Palos Hills Connection and Pump Station Building.....	33
SECTION 12.	CONSTRUCTION BY MUNICIPAL CUSTOMERS.....	33
SECTION 13.	COORDINATION AND COMPLETION OF THE 2013 REGIONAL SYSTEM IMPROVEMENTS AND FUTURE PROJECTS.....	33
	A. 2013 Regional System Improvements.....	33
	B. Contracts.....	34
	C. Palos Park Option to Upgrade the Size of Its System Connection Main.....	34
	D. Realignment of Transmission Main.....	35
SECTION 14.	AIR GAP.....	35
SECTION 15.	PRICE AND TERMS OF PAYMENT; CERTAIN LIMITS ON RATES AND CHARGES; TRUE UP; RECOGNITION OF LIEN OF BONDS.....	35

A.	Operation and Maintenance Costs.....	35
B.	Capital Costs and Charges.....	36
C.	Other Non-Operating Charges.....	36
D.	Old Bonds Payments	38
E.	True Up.....	38
F.	Recognition of Lien of Bonds	39
SECTION 16.	PAYMENTS TO CHICAGO	39
A.	Timely Payments	39
B.	Late Payments	39
SECTION 17.	ARREARAGES.....	39
SECTION 18.	FURTHER COVENANTS	40
A.	Payments Due Hereunder are Limited to Revenues Pledged	40
B.	Lien Priority of Payments Under Agreement.....	40
C.	Mutual Cooperation in Issuance of Obligations.....	40
D.	Segregate Revenues.....	41
E.	General Covenant to Operate Properly	41
F.	Accounting and Audit	41
G.	Maintain Ownership of Oak Lawn Regional Water System and Municipal Customer Water System and Properties	41
H.	Tax Status	41
I.	Statement of Mutual Cooperation Process	42
J.	No Agency, Partnership or Joint Venture	43
SECTION 19.	SERVICE TO POLITICAL SUBDIVISIONS	43
SECTION 20.	BILLINGS AND COMPUTATIONS; SECURITY DEPOSIT IN CERTAIN EVENTS	43
A.	Delivery; Computation; Verify	43
B.	Notify Each Month	43
C.	Security Deposit in Certain Events	44
D.	Access to Records; Disputes	44
E.	Tinley Park Role in Billing Mokena and New Lenox.....	45
SECTION 21.	FUTURE WATER CUSTOMERS; SPECIAL CONNECTION FEES.....	45
A.	Permit Future Water Customers	45
B.	To Pay Special Connection Fee for Capital Costs and Charges.....	46
C.	To Pay Proportionate Shares	47
D.	To Pay Old Bonds Special Connection Fee	47
SECTION 22.	SPECIAL CONNECTION FEE PAYMENTS TO OAK LAWN RETAIL WATER SYSTEM AND CERTAIN MUNICIPAL CUSTOMERS	47

SECTION 23.	INDEMNITY/INSURANCE.....	47
	A. Municipal Customer Indemnity.....	47
	B. Oak Lawn Indemnity.....	48
	C. Insurance.....	48
	D. Notice of Claims.....	48
SECTION 24.	COMPLIANCE WITH ALL APPLICABLE RULES AND REGULATIONS.....	48
SECTION 25.	CONSEQUENTIAL DAMAGES.....	48
SECTION 26.	APPROVALS AND CONSENTS; CORPORATE CONSENT OBTAINED; EXECUTIVE CONSENT OBTAINED.....	48
	A. In General.....	48
	B. Corporate Consent Obtained.....	49
	C. Executive Consent Obtained.....	49
SECTION 27.	FORCE MAJEURE.....	49
SECTION 28.	ENFORCEMENT.....	50
	A. Oak Lawn to Enforce.....	50
	B. May Pursue Any Remedies.....	50
	C. Failure by Oak Lawn.....	50
	D. Pursuit of Legal Remedies.....	50
SECTION 29.	DEFAULT.....	50
	A. Oak Lawn May Immediately Terminate.....	50
	B. Oak Lawn May Terminate After Notice and Opportunity to Cure.....	50
	C. Certain Effects of Termination.....	51
	D. Municipal Customers May Not Terminate.....	51
SECTION 30.	DISPUTE RESOLUTION.....	51
	A. Negotiation.....	51
	B. Continuation of Services and Payments.....	52
	C. Remedies.....	52
SECTION 31.	SUBSTITUTION OF MORE FAVORABLE PROVISIONS.....	52
	A. Copy Provided.....	52
	B. Customer Determination.....	52
	C. Notice to Oak Lawn.....	52
	D. Disputes.....	52
	E. Mediation.....	52
	F. Further Remedies.....	53

SECTION 32.	RECORDS	53
SECTION 33.	SUCCESSORS AND ASSIGNS	54
SECTION 34.	NOTICES.....	54
SECTION 35.	SECTION AND OTHER HEADINGS	55
SECTION 36.	CONSTRUCTION	55
SECTION 37.	SUPERSEDER; AMENDMENT; WAIVER.....	55
	A. Exhibits.....	55
	B. Entire Agreement	55
	C. Amendments and Waivers.....	55
	D. Limitations on Modifications	55
SECTION 38.	SEVERABILITY	56
SECTION 39.	CHOICE OF LAW.....	56
SECTION 40.	EXECUTION IN COUNTERPARTS.....	56
SECTION 41.	EFFECTIVE DATE AND TERM OF AGREEMENT	56
	A. Effective Date	56
	B. Term	56
	C. Termination and Renewal	56
	D. Partial Termination Due to Failure of Oak Lawn to Construct 2013 Regional System Improvements	57

EXHIBITS

- A. Description of Oak Lawn Retail Water System
- B. Oak Lawn Regional Water System Points of Delivery to Municipal Customers
- C. Description of Existing Oak Lawn Regional Water System and 2013 Regional System Improvements
- D. Municipal Customers' IDNR Approved Lake Michigan Water Allocations and Contractual Service Requirements
- E. Proportionate Shares of Capital Costs and Charges
- F. Allocation of Electricity Costs
- G. Allocation of Pump Station Maintenance Costs
- H. Allocation of Transmission Main Maintenance Costs
- I. Required Municipal Customers Improvements
- J. Contracts that Municipal Customers Have with Others to Supply Water
- K. Payments Due to Oak Lawn for "Old Bonds" and Old Bonds Special Connection Fee
- L. Determinations of Available Capacity
- M. Sample Special Connection Fee Calculation
- N. Superseded Intergovernmental Agreements
- O. 2013 Financing Plan and Parameters for the 2013 Regional System Improvements
- P. Statement of Mutual Cooperation Process
- Q. Aggregate Costs Template
- R. Budget Template

**FIRST AMENDED AND RESTATED
•REGIONAL WATER SYSTEM•
WATER SALE, PURCHASE AND SERVICE AGREEMENT
BETWEEN THE VILLAGE OF OAK LAWN, ILLINOIS AND
CERTAIN OF ITS MUNICIPAL CUSTOMERS**

This Water Sale, Purchase and Service Agreement first made and entered into as of the Effective Date defined below, and amended as of November 1, 2020, by and between the VILLAGE OF OAK LAWN, COOK COUNTY, ILLINOIS, an Illinois municipal corporation and home rule unit duly organized and existing under the laws of the State of Illinois ("*Oak Lawn*"), and each of the following units of local government who shall become signatories to this Agreement (the "*Southwest System Customers*"):

Village of Mokena
Village of New Lenox
City of Oak Forest

Village of Orland Park
Village of Tinley Park

all of Oak Lawn and the named municipalities referred to collectively as the "*Parties*" and each individually as a "*Party*."

WITNESSETH:

PREAMBLES

A. The City of Chicago ("*Chicago*") currently owns and operates a water system ("*Chicago Water System*"), which supplies Lake Michigan derived raw water treated to then current potable water standards in accordance with applicable State of Illinois and United States federal laws ("*Chicago Water*") to various customers, including Oak Lawn.

B. A municipal water system (a "*Water System*") means a system for the supply of water, including but not limited to all facilities and equipment, land, easements, rights-of-way over lands and waters, pumping, storage facilities, mains, pipelines and appurtenances acquired and used or useful for the purposes of treating, providing and transmitting water to customers of such municipality, and also includes, where in place, such facilities, equipment, land, water rights, easements, rights-of-way, and appurtenances so acquired and used or useful for the purpose of taking and treating water.

C. Oak Lawn owns and operates a Water System, consisting of three major elements described as follows: (1) that portion of the Water System that is used to service its retail customers (as now in existence and as improved in the future, the "*Oak Lawn Retail Water System*" or its "*Municipal Customer Water System*"), described in *Exhibit "A"* attached hereto; (2) that portion of the Water System (as now in existence and as improved in the future, the "*Oak Lawn Regional Water System*" as more particularly defined in the text below) which serves all of its customers not served by the Oak Lawn Retail Water System (consisting of municipalities for municipal use and for resale by such municipalities to residents and others); and (3) the

Oak Lawn Southeast System (as defined in the text below), which may or may not become part of the Oak Lawn Regional System as described in Preamble H below.

D. The Oak Lawn Regional Water System delivers Chicago Water to municipalities either directly or indirectly through adjacent Water Systems, described as follows: (1) a system owned and operated by Oak Lawn (the "*Oak Lawn Southeast System*") serving the Villages of Country Club Hills, Matteson, and Olympia Fields (which system may become part of the Oak Lawn Regional System as described in Preamble H below), and (2) a system **not** owned or operated by Oak Lawn (the "*Tinley Park Branch System*") serving the Villages of Tinley Park, Mokena and New Lenox and which may serve the Illinois American Water Company at its service area in the Village of Orland Hills and vicinity. (The Oak Lawn Regional Water System does not include the Tinley Park Branch System).

E. The current municipal customers ("*Municipal Customers*") of the Oak Lawn Regional Water System are as follows: (1) the Oak Lawn Retail Water System; (2) Village of Chicago Ridge ("*Chicago Ridge*"); (3) City of Country Club Hills ("*Country Club Hills*") as served by the Oak Lawn Southeast System; (4) Village of Matteson ("*Matteson*") as served by the Oak Lawn Southeast System; (5) Village of Mokena ("*Mokena*") as served through the Tinley Park Branch System; (6) Village of New Lenox ("*New Lenox*") as served through the Tinley Park Branch System; (7) City of Oak Forest ("*Oak Forest*"); (8) Village of Olympia Fields ("*Olympia Fields*") as served by the Oak Lawn Southeast System; (9) Village of Orland Park ("*Orland Park*"); (10) City of Palos Hills ("*Palos Hills*"); (11) Village of Palos Park ("*Palos Park*"); and (12) Village of Tinley Park ("*Tinley Park*") as served through the Tinley Park Branch System; *provided, however*, that (a) such term shall not include a municipality no longer served by the Oak Lawn Regional Water System for a reason other than *force majeure*; (b) as to each covenant or representation of a Municipal Customer made in this Agreement, such term is limited to the Parties hereto; and (c) Chicago Water to be delivered to Mokena and New Lenox shall be delivered to Tinley Park at the Points of Delivery to the Tinley Park Branch System.

F. Each Municipal Customer currently owns and operates its own Water System (each a "*Municipal Customer Water System*"). For convenience and clarity, Chicago Ridge, Palos Hills, and Palos Park may be referred to as the "*North System Customers*"; Country Club Hills, Matteson, and Olympia Fields may be referred to as the "*Southeast System Customers*"; and Mokena, New Lenox, Oak Forest, Orland Park and Tinley Park may be referred to as the "*Southwest System Customers*".

G. The points of delivery (the "*Points of Delivery*") from the Oak Lawn Regional Water System to the Oak Lawn Retail Water System and to each of the Southwest System Customers are as shown in *Exhibit "B"* attached hereto.

H. Oak Lawn, through the Oak Lawn Regional Water System and the Oak Lawn Southeast System, serves Chicago Water to the Southeast System Customers pursuant to existing contracts (the "*Existing Southeast Customer Contracts*"), copies of which all Parties have received; Oak Lawn has offered a Conforming Agreement (as hereinafter defined) to the North System Customers and to the Southeast System Customers; and Oak Lawn anticipates that the North System Customers, who prior to the Effective Date are without a contract for Chicago Water,

will execute and deliver Conforming Agreements (when so executed by the North System Customers and Oak Lawn, the "*North Customer Agreements*"), which North Customer Agreements shall be on file in the office of the Oak Lawn Village Clerk. As of the time of the offer of this Agreement to the Southwest System Customers, there is no expectation or determination as to whether the Southeast System Customers will enter into a Conforming Agreement (should they do so, it may be referred to as the "*New Southeast Customer Agreement*"); and the Parties hereto acknowledge that insofar as this Agreement allows, but is not dependent on, execution and delivery of the New Southeast Customer Agreements, certain provisions herein have been written in the alternative, either of which is acceptable to the Parties.

I. So long as the Southeast System Customers do not execute the Conforming Agreement, the Oak Lawn Southeast System will remain an independent water system and not be a part of the Oak Lawn Regional System. Subject to the terms of this Agreement, the Southeast System Customers may enter into future written water agreements with Oak Lawn (becoming "*Future Water Customers*" as hereinafter defined) and, further, it is possible that Oak Lawn may enter into future written agreements to supply other municipalities or private entities with Chicago Water through the Oak Lawn Regional Water System (thereby also becoming Future Water Customers) or to supply Chicago Water to Emergency Water Customers (as hereinafter defined).

J. Each Municipal Customer as Party to this Agreement finds that it is advisable for such Municipal Customer to continue to obtain from the Oak Lawn Regional Water System a continuing supply of Chicago Water for its Municipal Customer Water System.

K. Oak Lawn finds that it is advisable to supply Chicago Water to the Municipal Customers who are Parties pursuant to the terms and conditions of this Agreement.

L. Oak Lawn has provided by contract with Chicago for a supply of Chicago Water pursuant to the "Water Supply Agreement between the City of Chicago, Illinois, and the Village of Oak Lawn, Illinois," dated February 8, 2013, Agreement No. OL-2013 ("*Chicago-Oak Lawn Agreement*").

M. Oak Lawn has determined and the Municipal Customers as Parties to this Agreement have concurred that the capacity of the existing Oak Lawn Regional Water System ("*Current System Capacity*") is not adequate to serve the needs of the Municipal Customer Water Systems, as such needs may exist as of the Effective Date and through the year 2030; and Oak Lawn has determined to improve and expand the Oak Lawn Regional Water System with the goal of providing the Municipal Customers with an adequate supply of Chicago Water (the "*2013 Regional System Improvements*"), which 2013 Regional System Improvements shall include but not be limited to the installation of a "West Side Transmission Main" and associated piping, valves, pump station improvements, standby engine generator improvements, and electrical distribution and motor control equipment improvements; and the preliminary description of which improvements is as depicted in *Exhibit "C"* attached hereto.

N. To pay the costs of the 2013 Regional System Improvements, Oak Lawn has determined that it is necessary for it to borrow money and issue its New Series Bonds (as hereinafter defined) in evidence thereof.

O. Each Municipal Customer has received from the State of Illinois Department of Natural Resources (“IDNR”), a current allocation of Lake Michigan water as shown in *Exhibit “D”* attached hereto which (as shown) includes allocations for the listed years up to and including the year 2030 (the allocation for each year as shown in said Exhibit being the “*Current Year Allocation*” for such year and the allocation for the year 2030 as shown in said Exhibit being the “*2030 Allocation*”).

P. Pursuant to the Illinois Municipal Code, including but not limited to, 65 ILCS 5/11-124-1 *et seq.*, 65 ILCS 5/11-129-1 *et seq.*, and 65 ILCS 5/11-139-1 *et seq.*, the Illinois Intergovernmental Cooperation Act, 5 ILCS 220/1 *et seq.*, Article VII, Section 10 of the 1970 Constitution of the State of Illinois, and applicable home rule powers of New Lenox, Oak Lawn, Oak Forest, Orland Park, and Tinley Park under Article VII, Section 6 of the 1970 Constitution of the State of Illinois, Oak Lawn and the Municipal Customers are authorized to enter into this Agreement.

Q. Except as expressly provided or required by the terms of this Agreement, nothing in this Agreement is intended to cause or result in relinquishment of ownership or change in use by Oak Lawn in any part of the Oak Lawn Retail Water System or Oak Lawn Regional Water System or to cause or result in the relinquishment of ownership or change in use by any Municipal Customer in any part of its respective Municipal Customer Water System; *provided, however*, that Oak Lawn expressly acknowledges (1) the use of an existing transmission main, beginning at 146th Street and Central Avenue and ending at the existing Point of Delivery to Orland Park (the “*Orland Spur One Main*”) which is owned by Orland Park, (2) the use of a new transmission main to be constructed beginning at 151st Street and the ComEd Corridor west of Harlem Avenue and ending at the existing Point of Delivery to Orland Park (the “*Orland Spur Two Main*”) which will be owned by Orland Park and (3) the requirement that the Oak Lawn Regional Water System maintain said mains in accordance with Sections 11.C and D of this Agreement.

R. To better assure continuity and cooperation among the Parties, they have agreed to the Statement of Mutual Cooperation Process as set forth in *Exhibit “P”* attached hereto.

S. Certain costs and amounts (including debt service on the Old Bonds) due to or from certain of the Parties or other municipalities served by the existing Oak Lawn Regional Water System must be preserved and provided for under this Agreement, as set forth in *Exhibit “K”* attached hereto.

T. Oak Lawn and the other Parties hereto have each, respectively, duly authorized their respective Presidents or Mayors to sign and their Municipal Clerks to attest this Agreement.

NOW, THEREFORE, in consideration of the foregoing, the mutual covenants and undertakings contained herein, and other valuable consideration the receipt and sufficiency of which is hereby acknowledged by the undersigned, the Parties hereby agree as follows:

Section 1. Recitals and Definitions.

A. *Recitals.* The above paragraphs and recitals are hereby incorporated by reference, as if set forth within this Section 1.

B. *Definitions.* Capitalized words and terms used in this Agreement shall have the meanings given them, unless the context or use clearly indicates another or different meaning is intended. Words and terms defined in the singular may be used in the plural and vice-versa. Reference to any gender shall be deemed to include the other and also inanimate persons, such as corporations, where applicable.

“*Aggregate Costs*” means all costs to be assessed and payable pursuant to this Agreement, except payments to be made for the Old Bonds, and includes, without limitation, *inter alia*, all Operation and Maintenance Costs, Capital Costs and Charges, Other Non-Operating Charges, and Default Costs.

“*Aggregate Costs Template*” means that template for presentation of Aggregate Costs as shown in *Exhibit “Q”*.

“*Agreement*” means this Water Sale, Purchase and Service Agreement.

“*Asset Management Program*” means a written document providing asset management planning to determine the condition, and identify maintenance, rehabilitation and replacement needs, of the Oak Lawn Regional Water System, in a manner consistent with the International Infrastructure Management Manual, International Edition 2011, by the National Asset Management Support Group, and providing for the implementation of such system operations, repairs, rehabilitations and replacement as will meet such needs in a timely and practical manner.

“*Arrearages*” means the amount in arrears when any Municipal Customer does not pay its share of Aggregate Costs when due, as more fully defined in Section 17.

“*Authorized Representative*” means such term as is defined in the text below, relating to Executive Consent Obtained, in Section 26.C.

“*Available Capacity*” means the capacity of the Oak Lawn Regional Water System to deliver Chicago Water from time to time in excess of the obligation at such time to deliver Chicago Water pursuant to (1) this Agreement including the required Daily Peaking Factor, (2) Existing Southeast Customer Contracts or New Southeast Customer Agreements (as applicable), (3) North Customer Agreements, (4) agreements with Future Water Customers then in full force and effect, and (5) agreements with Emergency Water Customers then in effect. Available Capacity shall be determined using the applicable methodology set forth in *Exhibit “L”* by an independent consulting engineer having a national reputation for expertise in such matters and selected by Oak Lawn.

“*Bid Package*” means the bidding and construction documents, drawings, specifications, and related documents related to a segment or phase of the construction of 2013 Regional System Improvements, as listed in *Exhibit “C”*.

“*Bond*” means and includes any instrument by whatever name given providing for the payment of money executed by or on behalf of Oak Lawn or which Oak Lawn has assumed or agreed to pay, including, without limitation of the foregoing, bonds, notes, contracts, leases, loan agreements, certificates, and any other form of third party indebtedness, the proceeds of which are used to pay Aggregate Costs or provide reserves for the same; *provided, however*, that the definition of Bonds expressly excludes the Old Bonds.

“*Bond Counsel*” means counsel of recognized standing in the field of law relating to municipal bonds.

“*Budget Template*” means that template for presentation of the budget for Systems Operations Costs as shown in *Exhibit “R”*.

“*Buy In Base*” means all Capital Costs and Charges as paid from the Effective Date up until the Connection Fee Date, as future valued from the due dates of such costs to the Connection Fee Date at the weighted average true interest cost of all Bonds ever issued on or after September 1, 2013 for the Oak Lawn Regional Water System compounded annually.

“*Buy In Base for Old Bonds*” means the debt service principal and interest paid by Oak Lawn on the Old Bonds through the Connection Fee Date for the improvements proposed to be utilized by the Southeast System Customer or other Future Water Customer pursuant to Section 21.D and *Exhibit “K”* of this Agreement.

“*Capital Costs and Charges*” means and includes all capital costs payable or accrued in a given period of the Oak Lawn Regional Water System, and includes, for purposes of this Agreement, and without limitation, *inter alia*, all of the following: (1) interest on and principal of and premium, if any, on all Bonds; (2) payments with respect to interest rate exchange agreements entered into in connection with any Bonds; (3) bond insurance, letter or line of credit payments or fees, remarketing fees, or like charges in connection with the issuance of Bonds; (4) rating agencies, legal, financial, administrative, trustee, bond registrar, paying agent, depository, filing and similar fees in connection with the issuance of Bonds; (5) reserves to be provided for debt service on Bonds; and (6) Default Costs Allocable to Bonds.

“*Chicago*” means the City of Chicago.

“*Chicago-Oak Lawn Agreement*” means the Water Supply Agreement Between the City of Chicago, Illinois and the Village of Oak Lawn, Illinois dated February 8, 2013, Agreement No. OL-2013.

“*Chicago Ridge*” means the Village of Chicago Ridge, Illinois.

“Chicago Water” means the Lake Michigan derived raw water treated to the then current potable water standards in accordance with applicable State of Illinois and United States federal laws.

“Chicago Water System” means a water system currently owned and operated by the City of Chicago.

“Common Usage Rate” means a rate to be paid by a Municipal Customer or Future Water Customer for a portion of the Aggregate Costs to be paid by such Municipal Customer or Future Water Customer, stated as a dollar cost per 1,000 gallons of Chicago Water delivered, and determined on the basis of the amount of Chicago Water delivered to such Municipal Customer or Future Water Customer at its Point(s) of Delivery in the applicable period.

“Component” means a material component of the Oak Lawn Regional Water System which provides service to a Municipal Customer or Future Water Customer, as applicable, based upon the report of an independent engineer.

“Component Cost” means the cost of a Component.

“Component Cost Share” means the share in a Component Cost determined by a fraction the numerator of which shall be a Municipal Customer’s or Future Water Customer’s 2030 Allocation, as applicable, and the denominator of which shall be the sum of the 2030 Allocations of the Municipal Customer or Future Water Customer, as applicable, which also are served by the Component; *provided, however*, that Oak Lawn has been allocated an additional Component Cost Share (resulting in an increased Proportionate Share) representing its ownership, right, and title to the Oak Lawn Reserved Share.

“Conforming Agreement” means a water sale, purchase and service agreement in substantially the form of this Agreement (excepting, expressly, the Statement of Mutual Cooperation Process, which may, but need not be, a part of any such Agreement) having no Favorable Provision.

“Connection Fee Date” means the date on which a Future Water Customer (1) connects to the Oak Lawn Regional Water System or (2) if such Customer is already connected to the Oak Lawn Regional Water System, the effective date of the new contract.

“Corporate Consent Obtained” means such term as is defined in Section 26.

“Cost Methodology” means the basis for allocation of Proportionate Shares hereunder, being the determination of Component Cost Shares based upon the report of an independent consulting engineer.

“Country Club Hills” means the City of Country Club Hills, Illinois.

“Current System Capacity” means the capacity of the existing Oak Lawn Regional Water System.

“Current Year Allocation” means the allocation of Chicago Water each Municipal Customer has received from the IDNR for each given year as conclusively determined for all purposes of this Agreement by reference to *Exhibit “D”*.

“Daily Peaking Factor” means the maximum amount of Chicago Water the Oak Lawn Regional Water System is capable of delivering to a given Municipal Customer but not less than an amount equal to such Municipal Customer’s Current Year Allocation divided by 365 (expressed in millions of gallons) multiplied by 2.0.

“Default Costs” means costs paid by Municipal Customers due to the default by other Municipal Customers to pay Aggregate Costs as required by Section 15; *provided, however*, such costs shall not include the portion of Aggregate Costs allocable to Equitable Return.

“Default Costs Allocable to Bonds” means the portion of Default Costs allocable to the payment of the amounts noted in clauses (1) to (5), inclusive, of Capital Costs and Charges.

“Default Costs Allocable to Other Aggregate Costs” means all Default Costs other than Default Costs Allocable to Bonds.

“Default Proportionate Share” means a percentage that is equal to 100 times a fraction, the numerator of which shall be the Proportionate Share (as defined herein) of each Municipal Customer and the denominator of which shall be the sum of the Proportionate Shares of all of the Municipal Customers then not in default with respect to a payment required for Bonds.

“Effective Date” means the date defined as such in the text of this Agreement in Section 4.1.

“Electricity Costs” means all costs of electricity, including demand charges, of the Oak Lawn Regional Water System allocated to each Municipal Customer in accordance with the relative shares as set forth in *Exhibit “F”* attached hereto.

“Emergency Borrowings” means such term as defined in Section 4.D.

“Emergency Event” means an unexpected condition that, if not addressed by Oak Lawn as the operator of the Oak Lawn Regional Water System, poses an immediate risk to the operation of or of failure to operate the Oak Lawn Regional Water System that will cause damage to health, property or the environment.

“Emergency Event Costs” means only those costs necessary to eliminate the immediate risk of damage to health, property or the environment presented by an Emergency Event, but not including the balance of the System Repair or Major Capital Cost necessary to complete any longer term repair or remediation that may be necessary thereafter.

“Emergency Water Customers” means customers purchasing Chicago Water from Oak Lawn on a short-term basis from time to time, which purchases are subject to the standards set forth in Section 7.D of this Agreement and will not adversely affect the Municipal Customers.

“Equitable Return” means the amount set forth as follows:

(A) for purposes of this definition, the following further terms are defined:

(1) *“Annual Increase”* means an increase in the rate of return over the rate for the prior Fiscal Year equal to the greater of 2% or the increase in the PPI, year over year, as most recently published;

(2) *“Initial Rate”* means \$0.05 (5 cents) per 1,000 gallons of Chicago Water delivered under this Agreement;

(3) *“Subsequent Rate”* means \$0.10 (10 cents) per 1,000 gallons of Chicago Water delivered under this Agreement;

(B) For the Fiscal Year 2014 and each Fiscal Year thereafter until the end of the Fiscal Year 2020, Equitable Return shall be the Initial Rate;

(C) For the Fiscal Year 2021 and each Fiscal Year thereafter until the end of the Fiscal Year after the Fiscal Year in which the 2013 Regional System Improvements are Substantially Complete and Operational, Equitable Return shall be the Subsequent Rate; and

(D) For each Fiscal Year thereafter Equitable Return means the rate of such return for the prior Fiscal Year plus the Annual Increase.

“Executive Consent Obtained” means such term as is defined in Section 26.

“Existing Southeast Customer Contracts” means the contracts in place as of July 1, 2013, pursuant to which Oak Lawn is supplying the Southeast System Customers with Chicago Water through the Oak Lawn Regional Water System and the Oak Lawn Southeast System.

“Favorable Provision” means any provision that is more advantageous to or protective of the interests of any other Municipal Customer or Future Water Customer than the provisions of this Agreement are to the interests of the Southwest System Customers; *provided, however*, that it shall not include any provision that is temporary in nature and addresses unique circumstances applicable only to the other Municipal Customer or Future Water Customer.

“Financing Plan and Parameters” means a plan and related parameters for the financing of the construction of one or more System Projects. Each Financing Plan and Parameters shall include (but are not limited to) the following elements: a description of the proposed Bonds, including the source of funds of the proposed Bonds, the structure (fixed, variable or other), the maximum principal amount, interest rate parameters, duration of the repayment period, and the time at which repayments by Oak Lawn will be required (if such repayment schedule necessitates that such Capital Costs and Charges be billed and payable on a schedule other than quarterly as described in Section 15.B), and the maximum amounts for the various reserve funds or accounts required in connection therewith.

“Fiscal Year” means the fiscal year of Oak Lawn and is the calendar year, January 1 through December 31; *provided, however*, that Oak Lawn may change its fiscal year or the fiscal year solely as it relates to the Oak Lawn Regional Water System from time to time upon reasonable notice to the Municipal Customers and upon taking reasonable transitional measures with respect to budgeting and establishment of rates.

“Force majeure” means acts of God, strikes, lockouts or other industrial disturbances, acts of a public enemy, orders of any kind of the Government of the United States, of the State of Illinois, or of any civil or military authority, insurrections, riots, epidemics, landslides, lightning, earthquakes, fires, hurricanes, tornadoes, storms, floods, washouts, droughts, arrests, restraints of government and people, civil disturbances, explosions, breakage or accidents to machinery, pipelines, canals, or tunnels, partial or entire failure of Chicago Water supply, and inability on the part of Oak Lawn to deliver Chicago Water, or of any Municipal Customer to receive Chicago Water, that is not as a result of the Party’s own actions or inactions, and on account of any other causes not reasonably within the control of the Party claiming such inability.

“Full Water Requirements” means, with respect to a Municipal Customer, the amount of Chicago Water necessary from time to time to meet the potable water requirements of (1) all then current customers served by the Municipal Customer Water System (including municipal use where applicable) whether within or outside of the corporate limits or applicable service area of the Municipal Customer, and (2) all then current customers served by a Municipal Customer’s wholesale Water System, if any.

“Future Improvements” means future improvements to a Municipal Customer Water System involving structures for the receipt of Chicago Water from Oak Lawn.

“Future Series Bonds” means, and is limited to, Bonds the proceeds of which are necessary or advisable to accomplish any lawful corporate purpose of the Oak Lawn Regional Water System, including but not limited to the following: (1) to repair, replace, maintain, rehabilitate or otherwise make more efficient or usable, or to improve the Oak Lawn Regional Water System in a manner to continue to serve or to better serve the Municipal Customers; (2) to otherwise improve or extend the Oak Lawn Regional Water System in a manner, which will not be likely to increase the costs to the Municipal Customers of Chicago Water service over the term of this Agreement; or (3) will result in long-term benefits to Oak Lawn and to the Municipal Customers, and includes Bonds in one or more series, issued from time to time, to refund or further refund such Bonds.

“Future Water Customers” means municipalities or private entities with whom Oak Lawn may enter into future written agreements to supply Chicago Water through the Oak Lawn Regional Water System.

“IDNR” means the State of Illinois Department of Natural Resources or a successor to the applicable responsibilities of such department.

“IEPA” means the State of Illinois Environmental Protection Agency or a successor to the applicable responsibilities of such agency.

“Major Capital Costs” means, for any Fiscal Year, those acquisitions, repairs, replacements, rehabilitations, or improvements which would qualify as System Repairs but for their cost, either as a discrete Repair Item or due to the aggregate of such costs; *provided, however*, such term shall not include any costs of the 2013 Regional System Improvements.

“Matteson” means the Village of Matteson, Illinois.

“Meters, Valves and Controls” means the necessary meter vaults and water meters for measuring properly the quantity of Chicago Water delivered under this Agreement and the structures Oak Lawn deems necessary to house such equipment and devices.

“Mokena” means the Village of Mokena, Illinois.

“Moody’s” means Moody’s Investors Service, Inc., its successors and assigns, and, if such corporation shall no longer perform the functions of a securities rating agency, “Moody’s” shall be deemed to refer to any other nationally recognized securities rating agency designated by Oak Lawn.

“Municipal Customer Improvements” means improvements planned for construction by the Municipal Customers as set forth in *Exhibit “I”*.

“Municipal Customers” means the current municipal customers of the Oak Lawn Regional Water System as follows: (1) the Oak Lawn Retail Water System; (2) Chicago Ridge; (3) Country Club Hills as served by the Oak Lawn Southeast System; (4) Matteson as served by the Oak Lawn Southeast System; (5) Mokena as served through the Tinley Park Branch System; (6) New Lenox as served through the Tinley Park Branch System; (7) Oak Forest; (8) Olympia Fields as served by the Oak Lawn Southeast System; (9) Orland Park; (10) Palos Hills, (11) Palos Park; and (12) Tinley Park as served in part through the Tinley Park Branch System.

“Municipal Customer Water System” means the retail Water System currently owned and operated by each Municipal Customer.

“Municipal Manager” means the chief administrative officer of the Municipal Customer (whose title shall usually be “Village [City] Manager” or “Village [City] Administrator”).

“New Lenox” means the Village of New Lenox, Illinois.

“New Series Bonds” means the one or more series of Bonds that will be issued by Oak Lawn for the purpose of financing the cost of the 2013 Regional System Improvements, and includes Bonds in one or more series, issued from time to time, to refund or further refund such Bonds.

“New Southeast Customer Agreements” means the Chicago Water sale, purchase and service agreements between Oak Lawn and the Southeast System Customers, based upon a Conforming Agreement, as and if executed and delivered on or before December 31, 2014.

“North Customer Agreements” means the Chicago Water sale, purchase and service agreements between Oak Lawn and North System Customers, based upon a Conforming Agreement, as and if executed and delivered on or before December 31, 2014.

“North System Customers” means Chicago Ridge, Palos Hills, and Palos Park.

“Oak Forest” means the City of Oak Forest, Illinois.

“Oak Lawn” means the Village of Oak Lawn, Illinois.

“Oak Lawn Regional Water System” means all real or personal property now in existence or obtained in the future used or useful in the treating (if and to the extent applicable), pumping, and maintenance of water delivery or transmission of Chicago Water to the Municipal Customers, Future Water Customers and Emergency Water Customers, except as follows: real or personal property obsolete or deemed, in the reasonable discretion of Oak Lawn, to be no longer used or useful to the Oak Lawn Regional Water System, and also such conduit or other pipes and appurtenances to be purchased solely at the cost of Oak Lawn for any of its corporate purposes and laid in easements acquired in connection with the construction and operation of said system.

“Oak Lawn Reserved Share” means 5 million gallons of water per day reserved to Oak Lawn above and beyond the rights granted under this Agreement to the Oak Lawn Retail Water System to Chicago Water for the use of such Oak Lawn Retail Water System.

“Oak Lawn Reserved Share Customer” means a municipality or private entity purchasing Chicago Water from Oak Lawn and from the Oak Lawn Reserved Share.

“Oak Lawn Retail Water System” means that portion of the Oak Lawn Water System that is used to service its retail customers, as now in existence and as improved in the future.

“Oak Lawn Southeast System” means the system owned and operated by Oak Lawn serving the Southeast System Customers.

“Old Bonds” means outstanding bonds issued by Oak Lawn, the proceeds of which were used to acquire, construct and install the portions of the Oak Lawn Regional Water System as it now exists, and are as shown (with related debt service requirements) in *Exhibit “K”* attached hereto, and includes bonds in one or more series, issued from time to time, to refund or further refund such bonds; and the debt service requirements payable by the Municipal Customers on the Old Bonds are as set forth in *Exhibit “K”*.

“Old Bonds Special Connection Fee” means such term as is described in Section 21.D and *Exhibit “K”*.

“Olympia Fields” means the Village of Olympia Fields, Illinois.

“Operation and Maintenance Costs” means and includes the cost of Chicago Water pursuant to Section 15.A(1) of this Agreement, Electricity Costs, Pump Station Maintenance

Costs, Transmission Main Maintenance Costs and System Operations Costs. All cost items assigned to any of these categories of costs of the operation and maintenance of the Oak Lawn Regional Water System shall be as itemized in the budget and as set forth in the Budget Template and to be listed generally in the format included in the Budget Template; *provided, however*, such categories shall exclude, expressly, depreciation or amortization costs or charges or costs or charges allocated and billed as Capital Costs and Charges; and, *provided, further*, that in the event of any dispute as to the allocation of any Operations and Maintenance Costs, if it shall be determined that a cost is not properly allocable to any of the Electricity Costs, Pump Station Maintenance Costs or Transmission Main Maintenance Costs, in any re-computation, then such cost shall be deemed a System Operations Cost and be recouped in that manner.

“Orland Park” means the Village of Orland Park, Illinois.

“Orland Spur One Main” means the portion of the existing transmission main owned by Orland Park that begins at 146th Street and Central Avenue and ends at the existing Point of Delivery to Orland Park.

“Orland Spur Two Main” means a new transmission main to be owned by Orland Park that begins at 151st Street and the ComEd Corridor west of Harlem Avenue and ends at the existing Point of Delivery to Orland Park and is located in right-of-way other than 151st Street.

“Other Agreement” means an Oak Lawn contract or agreement for water sale, purchase or service with another Municipal Customer or Future Water Customer, other than an Oak Lawn Reserved Share Customer, that is approved by a party to such contract or agreement during one of the following periods: (i) within ninety (90) days prior to the approval of this Agreement by any of the Southwest Customers, (ii) any time after any of the Southwest Customers have approved this Agreement, or (iii) at any time during the Term of this Agreement or any extension of the Term.

“Other Non-Operating Charges” means charges or assessments to provide (1) a reserve for Operation and Maintenance Costs, (2) Equitable Return, (3) reserves for insurance purposes, whether to provide for tort or other liabilities or for insurance against damage or destruction or condemnation of the Oak Lawn Regional Water System, (4) net additional charges required by a rate covenant or rate covenants as made by Oak Lawn in connection with the issuance of Bonds, requiring rates for the Oak Lawn Regional Water System to be sufficient to provide for Operation and Maintenance Costs, payment of Bonds, and a certain additional percentage of Bond payments for what is known as “coverage,” deemed necessary or appropriate to obtain a rating in the second highest rating category by one or more appropriate rating agencies so providing a rating for Bonds (commonly referred to as “AA” or “Aa”), but in no event shall such coverage ratio be greater than 1.35, as may be set forth in any proceeding, resolution or ordinance or document so authorized, such as an indenture, of Oak Lawn providing for the issuance of Bonds, and which charge or assessment is not included within the definition of Capital Costs and Charges, and (5) amounts assessed for the Renewal, Repair and Replacement Reserve Fund.

“Palos Hills” means the City of Palos Hills, Illinois.

“Palos Park” means the Village of Palos Park, Illinois.

“Participating Customers” means the Municipal Customers and Future Water Customers (as more fully defined in Section 21.B).

“Party” or *“Parties”* means Oak Lawn and one or more of the Municipal Customers signatory hereto.

“Permitted Borrowings” means such term as is defined in Section 4.D, relating to the issuance of Future Series Bonds.

“Points of Delivery” means points of delivery of Chicago Water from the Oak Lawn Regional Water System to the Oak Lawn Southeast System Municipal Customers and to Tinley Park on behalf of the Tinley Park Branch System and the points of delivery to each of the other Municipal Customer Water Systems, all as shown in *Exhibit “B”* attached hereto.

“PPI” means the annual sum of the twelve (12) monthly increases or decreases in the Producer Price Index for Total Manufacturing Industries, not seasonally adjusted, as such monthly indexes appear in the PPI Detailed Report as published by the U.S. Department of Labor, Bureau of Labor Statistics, as finalized in May of each year for the previous calendar year, or if such index is no longer available, a reasonable replacement index.

“Projected Consumption” means the projected highest Chicago Water consumption of a Future Water Customer for any twelve (12) month period during the three years following the Connection Fee Date.

“Proportionate Share” means the share of the Capital Costs and Charges as charged under this Agreement and to be payable by each of the Municipal Customers, determined using the Cost Methodology, as a fair and equitable allocation, and is as set forth conclusively for all of the Municipal Customers as shown in *Exhibit “E”* attached hereto (said *Exhibit “E”* set forth in the alternative—Alternative 1 shall apply if Oak Lawn and the Southeast System Customers do not enter into New Southeast Customer Agreements and Alternative 2 shall apply if such Agreements be so entered into); *provided, however*, that the Proportionate Shares may be modified pursuant to Section 4.D(4).

“Pump Station Maintenance Costs” means all costs assigned to the maintenance of pumps and pump stations including System Repairs relating to same as reflected in the budget as set forth in the Budget Template, allocated to the Oak Lawn Retail Water System and to each Municipal Customer in accordance with the relative shares as set forth in *Exhibit “G”* attached hereto.

“Regional System Revenues” means all revenues from whatever source derived of the Oak Lawn Regional Water System, including all Municipal Customers; *provided, however*, Oak Lawn may exclude portions of such revenues from the lien of or the right to payment from any Bonds.

“Regional System Revenue Bonds” means, collectively, New Series Bonds and Future Series Bonds, as more fully defined in Section 4.

“Renewal, Repair and Replacement Reserve Fund” means the fund to be established by the Oak Lawn Regional Water System as provided by this Agreement to be used to provide a source of funds for Major Capital Costs, System Repairs, and Emergency Event Costs.

“S&P” means Standard & Poor’s Ratings Services, a division of The McGraw-Hill Companies Inc., its successors and assigns, and, if such entity shall no longer perform the functions of a securities rating agency, “S&P” shall be deemed to refer to any other nationally recognized securities rating agency designated by Oak Lawn.

“Security Deposit” means such term as is defined in Section 20.C.

“Southeast System Customers” means Country Club Hills, Matteson, and Olympia Fields.

“Southwest System Customers” means Mokena, New Lenox, Oak Forest, Orland Park and Tinley Park.

“Special Connection Fee” means a charge to a Future Water Customer (as more fully defined in Section 21.B).

“Substantially Complete and Operational” means the status of the 2013 Regional System Improvements as substantially complete and operational, as certified by the independent engineer in responsible charge of the project, which certification shall include a statement that the system as so improved is then capable of delivering not less than 95% of the required Chicago Water to be supplied to the Southwest System Customers pursuant to this Agreement in the year 2030.

“System Operations Costs” means and includes those costs assigned to the operation and maintenance of the Oak Lawn Regional Water System including System Repairs but not including the cost of Chicago Water pursuant to Section 15.A(1) of this Agreement, Electricity Costs, Pump Station Maintenance Costs, and Transmission Main Maintenance Costs. Costs not itemized on the Budget Template that are not properly charged to any other category of Operations and Maintenance Costs may be added to this definition of System Operations Costs, and allocations of costs shown on the Budget Template may be modified, only by Executive Consent Obtained; *provided, however*, that where Oak Lawn proposes to add a cost to this definition based on generally accepted accounting principles, Oak Lawn may do so without Executive Consent Obtained if it demonstrates that (1) the cost due to such principles is a required item and not a discretionary item, (2) Oak Lawn’s proposed implementation is an efficient and cost effective manner of implementation of the requirement, and (3) the cost does not add a cost to the Southwest System Customers in an amount of more than \$0.0125 (1.25 cents) per 1,000 gallons of Chicago Water delivered times the gallons so delivered in the Fiscal Year in which it is added; and *provided further* that Oak Lawn may not further increase that cost in any subsequent Fiscal Year without Executive Consent Obtained.

“System Project” means the proposed 2013 Regional System Improvements and each future Oak Lawn Regional Water System acquisition, repair, replacement, improvement or extension, whether paid for by Regional System Revenue Bonds or other sources of funds.

“System Repairs” means, for any Fiscal Year, those acquisitions, repairs, replacements, rehabilitations, or improvements, including for any Emergency Events (each, a **“Repair Item”**), necessary or advisable in the reasonable discretion of Oak Lawn for the continued efficient and effective operation of the Oak Lawn Regional Water System the costs of which do not exceed \$300,000 for Fiscal Year 2014, and for each Fiscal Year thereafter, said sum of \$300,000 adjusted for any increase or decrease in the PPI from that in effect for the year 2014.

“Tax-Advantaged Status” means a status governed by federal income tax law excluding from gross income for federal income tax purposes of the interest on any Bond or Bonds or the entitlement to a credit payment from the United States Treasury as relates to any Bond or Bonds.

“Tax Laws” means the federal income tax laws, as amended from time to time, including but not limited to, Section 141 of the Internal Revenue Code of 1986, as amended, and the Treasury Regulations or any rulings promulgated thereunder or as affected by a decision of any court of competent jurisdiction.

“Tinley Park” means the Village of Tinley Park, Illinois.

“Tinley Park Branch System” means a system not owned or operated by Oak Lawn serving Tinley Park, Mokena and New Lenox, and which may serve the Illinois American Water Company at its service area in the Village of Orland Hills and vicinity, and shall not be part of the Oak Lawn Regional Water System.

“Transmission Main Maintenance Costs” means all costs assigned to the maintenance of transmission elements of the Oak Lawn Regional Water System including pipes, and Meters, Valves and Controls, and including System Repairs relating to the same as reflected in the budget as set forth in the Budget Template, and allocated to the Oak Lawn Retail Water System and to each Municipal Customer in accordance with the relative shares as set forth in *Exhibit “H”*.

“Water System” means a municipal water system for the supply of water, including but not limited to all facilities and equipment, land, easements, rights-of-way over lands and waters, pumping, storage facilities, mains, pipelines and appurtenances acquired and used or useful for the purposes of treating, providing and transmitting water to customers of such municipality, and also includes, where in place, such facilities, equipment, land, water rights, easements, rights-of-way, and appurtenances so acquired and used or useful for the purpose of taking and treating water.

“2013 Financing Plan and Parameters” means the Financing Plan and Parameters for the 2013 Regional System Improvements as set forth in *Exhibit “O”* hereto.

“2013 Regional System Improvements” means improvements and expansions to the Oak Lawn Regional Water System determined by Oak Lawn with the goal of providing Municipal Customers with an adequate supply of Chicago Water; and such improvements and expansions

shall include but not be limited to the installation of a “West Side Transmission Main” and associated piping, valves, pump station improvements, standby engine generator improvements, and electrical distribution and motor control equipment improvements; and the preliminary description of which improvements is as depicted in *Exhibit “C”* attached hereto; and include, further, all legal, financial, engineering, advisory, Bond issuance and reserves, and other reasonably related costs of providing and financing such improvements or expansions.

“2030 Allocation” means the allocation of Chicago Water each Municipal Customer receives from the IDNR for the year 2030, fixed for purposes of this Agreement at the amounts shown in *Exhibit “D”*.

Certain terms may be defined in the text above and below.

Section 2. Oak Lawn to Serve and Municipal Customers to Take.

A. Basic Duties. Subject to the terms of this Agreement, Oak Lawn will provide and serve Chicago Water to the Municipal Customers through the Oak Lawn Regional Water System, and the Municipal Customers shall take Chicago Water and pay for same.

B. Nature of Payment Obligation; Take or Pay Obligation. Payments to be made under this Agreement shall be an operation and maintenance expense of each Municipal Customer Water System. Each Municipal Customer covenants that it will expressly provide in any future ordinance, resolution or other proceeding which obligates its Municipal Customer Water System for the payment of money that it will expressly declare payments pursuant to this Agreement to be an operation and maintenance expense. All Capital Costs and Charges due and payable hereunder shall be due and payable without setoff or counterclaim and irrespective of whether such supply of Chicago Water is ever furnished, made available or delivered to the Municipal Customer from the 2013 Regional System Improvements or whether any project for the supply of Chicago Water contemplated by this Agreement is completed, operable or operating and notwithstanding any suspension, interruption, interference, reduction or curtailment of the supply of Chicago Water from any such project.

Section 3. Conditions Precedent and Subsequent. It is expressly understood and agreed that any obligation on the part of Oak Lawn to deliver Chicago Water from the Oak Lawn Regional Water System as improved by the 2013 Regional System Improvements shall be expressly conditioned upon the following: (1) the Chicago-Oak Lawn Agreement being in full force and effect during the duration of this Agreement and Oak Lawn’s ability to secure and maintain an adequate supply of Chicago Water under the Chicago-Oak Lawn Agreement. Notwithstanding anything contained herein to the contrary, Oak Lawn shall not be obligated to supply Chicago Water in volume, flow rate or quality in excess of the Chicago Water which Chicago supplies to Oak Lawn; (2) approval by Chicago when required pursuant to the Chicago-Oak Lawn Agreement; (3) sale of the New Series Bonds, obtaining other financing, or a combination of New Series Bonds and other financing, in an amount or amounts sufficient to assure payment of all costs of the 2013 Regional System Improvements; (4) obtaining all necessary material, labor and equipment necessary for completion of the 2013 Regional System Improvements; and (5) receiving the necessary permits and approvals of all federal, state and local

governmental entities and agencies having jurisdiction over the 2013 Regional System Improvements or any aspect of same.

Section 4. Bonds; Finance.

A. Regional System Revenue Bonds. Oak Lawn and the Southwest System Customers understand and agree as to the following: (1) Old Bonds remain outstanding, are the obligations of certain Municipal Customers and are payable directly to Oak Lawn, not as Regional System Revenues, but as an independent obligation of the named Municipal Customers, all as described in *Exhibit "K"*; (2) Oak Lawn intends to issue New Series Bonds to pay the costs of the 2013 Regional System Improvements, some of which costs have already been incurred and paid and will be reimbursed from the proceeds of New Series Bonds; (3) New Series Bonds will be payable from Regional System Revenues; (4) for the proper management and operation of the Oak Lawn Regional Water System in the future, Oak Lawn intends to issue, from time to time, Future Series Bonds, payable from Regional System Revenues; and (5) all such Bonds except the Old Bonds as enumerated shall constitute the "*Regional System Revenue Bonds*".

B. Plan of Finance and Issuance of New Series Bonds for Purposes of 2013 Regional System Improvements. Oak Lawn shall use the proceeds of any New Series Bonds for paying the costs of the 2013 Regional System Improvements and for paying the costs of the refunding of said bonds from time to time in accordance with this Section 4.B and Section 4.C.

(1) Oak Lawn has submitted to the Municipal Customers a plan and parameters for the financing of the construction (collectively, "*2013 Financing Plan and Parameters*") of the 2013 Regional System Improvements with the New Series Bonds. The 2013 Financing Plan and Parameters are set forth in *Exhibit "O"* hereto. The 2013 Financing Plan and Parameters so submitted are hereby approved by the Southwest System Customers.

(2) The issuance of any New Series Bonds by Oak Lawn for the purpose of paying the costs of the 2013 Regional System Improvements shall be conditioned upon the following:

(a) If prior to the issuance of any New Series Bonds for the purpose of 2013 Regional System Improvements, Oak Lawn determines that its proposed financing will be in compliance with the Financing Plan and Parameters, Oak Lawn shall provide written notice to each Municipal Customer of such financing not less than forty-five (45) calendar days prior to the issuance of the New Series Bonds, which notice shall include a discussion demonstrating that the proposed New Series Bonds will be in compliance with the Financing Plan and Parameters and be accompanied by a certificate from a registered municipal advisor that in his or her (their) opinion, the proposed New Series Bonds will be in compliance with the Financing Plan and Parameters; *provided, however*, that no approval or consent of any kind will be required from the Municipal Customers in connection with the issuance of said New Series Bonds; or

(b) If prior to the issuance of any New Series Bonds for the purpose of paying the costs of the 2013 Regional System Improvements, Oak Lawn determines that its proposed financing will not be in compliance with the Financing Plan and Parameters, Oak Lawn shall provide to each Municipal Customer sufficient information to demonstrate why the proposed New Series Bonds will not comply with the Financing Plan and Parameters and shall explain the details of the proposed New Series Bonds. In this event, Oak Lawn shall not issue any portion of the New Series Bonds without Corporate Consent Obtained. Such consent may be requested for either the specific Bonds then to be issued or for an amendment to the subject Financing Plan and Parameters, or both.

C. Issuance of New Series Bonds for Refunding Purposes. The issuance of any New Series Bonds by Oak Lawn for a refunding purpose shall be conditioned upon the following:

(1) If Oak Lawn determines to issue New Series Bonds for refunding purposes and the proposed debt service for said refunding bonds will be in compliance with the Financing Plan and Parameters, Oak Lawn shall provide written notice to each Municipal Customer not less than forty-five (45) calendar days prior to the issuance of said refunding Bonds, which notice shall include a discussion demonstrating that the proposed New Series Bonds will be in compliance with the Financing Plan and Parameters and be accompanied by a certificate from a registered municipal advisor that in his or her (their) opinion, the proposed New Series Bonds will be in compliance with the Financing Plan and Parameters; then such refinancing may be undertaken by Oak Lawn without the consent of the Municipal Customers; or

(2) If Oak Lawn determines that the proposed debt service on said refunding bonds will not be in compliance with the Financing Plan and Parameters, Oak Lawn shall provide to each Municipal Customer sufficient information to demonstrate why the proposed New Series Bonds will not comply with the Financing Plan and Parameters and shall explain the details of the proposed New Series Bonds. In this event, Oak Lawn shall not issue any portion of the New Series Bonds for refunding purposes without Corporate Consent Obtained. Such consent may be requested for either the specific Bonds then to be issued or for an amendment to the subject Financing Plan and Parameters, or both.

D. Plan of Finance; Issuance of Future Series Bonds for Non-Refunding Purposes. The issuance of any Future Series Bonds for non-refunding lawful corporate purposes of the Oak Lawn Regional Water System by Oak Lawn shall be conditioned upon the following:

(1) For any issue of Future Series Bonds that meets each of the following conditions ("*Permitted Borrowings*");

(a) debt service on all Permitted Borrowings shall not exceed \$100,000 for Fiscal Year 2014 and, for each Fiscal Year thereafter, said sum adjusted for any increase or decrease in the PPI from that in effect for the year 2014; and

(b) the term of any given Permitted Borrowing shall not be longer than ten (10) years;

Oak Lawn shall provide written notice to each Municipal Customer of such Permitted Borrowing not less than thirty (30) days prior to the issuance of same; *provided, however*, that no approval or consent will be required from the Municipal Customers.

(2) Further, for any issue of Future Series Bonds that meets each of the following parameters ("*Emergency Borrowings*"), Oak Lawn shall be authorized to issue such Future Series Bonds:

(a) If the Bonds are to be issued to pay Emergency Event Costs; and

(b) Pursuant to Executive Consent Obtained.

For purposes of this Section 4.D(2), notice to a Municipal Customer shall be by telephone and confirmed in writing immediately by notice pursuant to Section 34 of this Agreement. Consent or denial of consent must be received in writing by email received within one week after the receipt of the written notice.

(3) For any Future Series Bonds that do not constitute Permitted Borrowings or Emergency Borrowings, Oak Lawn shall not issue such Future Series Bonds without Corporate Consent Obtained. Such consent shall be requested pursuant to a new Financing Plan and Parameters relating to the project or improvements then proposed. In the event a Financing Plan and Parameters is approved, each series of Future Series Bonds issued pursuant thereto shall be subject to the same procedural provisions as for New Series Bonds, contained at Section 4.B(2)(a) and (b), as applicable.

(4) In the event that the Southeast System Customers and Oak Lawn enter into the New Southeast Customer Agreement or a Conforming Agreement, the Proportionate Shares are as set forth in the table for that purpose in *Exhibit "E"*. That set of Proportionate Shares is based on the Oak Lawn Regional System being comprised of the physical assets of the System as it exists on the Effective Date and as improved by the 2013 Regional System Improvements. It is possible that a future System Project could be proposed that provides substantial improvements that benefit only the Southeast System Customers (as opposed to routine maintenance and repair of existing facilities) which proposal would affect Proportionate Shares (increasing same for the Southeast System Customers so served). It is expressly acknowledged that a proposal for Future Series Bonds to pay for such a System Project shall include a new proposed table of Proportionate Shares supported by the Cost Methodology.

E. Issuance of Future Series Bonds for Refunding Purposes. The issuance of any Future Series Bonds by Oak Lawn for refunding purposes shall be conditioned upon the following:

(1) If Oak Lawn determines to issue Future Series Bonds for refunding purposes and the proposed debt service for the refunding bonds will be in compliance with

a given Financing Plan and Parameters previously approved pursuant to Subsection D(3) of this Section above, Oak Lawn shall provide written notice to each Municipal Customer not less than forty-five (45) days prior to the issuance of said refunding Bonds, which notice shall include a discussion demonstrating that the proposed Future Series Bonds will be in compliance with the Financing Plan and Parameters and be accompanied by a certificate from a registered municipal advisor that in his or her (their) opinion, the proposed Future Series Bonds will be in compliance with the Financing Plan and Parameters; then such refinancing may be undertaken by Oak Lawn without the consent of the Municipal Customers, or

(2) If Oak Lawn determines that the proposed issuance of Future Series Bonds will not be in compliance with a Financing Plan and Parameters previously approved pursuant to Section 4.D(3), Oak Lawn shall provide to each Municipal Customer sufficient information to demonstrate why the proposed Future Series Bonds will not comply with the Financing Plan and Parameters and shall explain the details of the proposed Future Series Bonds. In this event, Oak Lawn shall not issue Future Series Bonds for refunding purposes without Corporate Consent Obtained. Such consent may be requested for either the specific Bonds then to be issued or for an amendment to the subject Financing Plan and Parameters, or both.

F. Cash Contributions. A Municipal Customer may provide a cash contribution at the time Oak Lawn proposes to issue any Bonds which are not Permitted Borrowings, Emergency Borrowings or Bonds to be issued to the IEPA pursuant to its water facilities loan program (or successor program) upon the terms and conditions as follows:

(1) Within thirty (30) days after receipt of notice by Oak Lawn of its intention to issue such Bonds, a Municipal Customer shall notify Oak Lawn of its intention to deliver cash for all or a part of such Municipal Customer's Proportionate Share of such Bond issue. Such notice shall be irrevocable and shall bind the Municipal Customer to pay to Oak Lawn for deposit into the appropriate project or refunding account the amount of such cash on or before the date of the closing of such Bonds. Oak Lawn shall reduce the size of the proposed Bond issue by the amount of the cash contribution to be supplied by the Municipal Customers.

(2) In consideration of the cash contribution, the Municipal Customer shall be deemed to have loaned the Oak Lawn Regional Water System such cash and have acquired a repayment obligation calculated as if the Municipal Customer shall have acquired a Bond having the position of a third lien Bond within the accounts of the Oak Lawn Regional Water System, which third lien Bond shall be deemed to amortize at the same rate, bearing the same rate or rates of interest, for the same term of years as the Bonds against which the cash contribution shall have been made.

(3) In each month in which a Capital Costs and Charges payment is due, Oak Lawn shall assess the amount necessary to repay the loan represented by the deemed Bond described above, including assessing the Municipal Customer to whom the repayment is due. Upon the payment due dates of the loan represented by the deemed Bond described

above, the Municipal Customer shall be credited with the amounts so due to the extent funds are available in the fund or account from which third lien Bonds are payable, such credit to be applied against the next monthly bill due from such Municipal Customer for all its share of Aggregate Costs.

G. Other System Project and Related Financing Permitted. Notwithstanding any other provision of this Agreement, Oak Lawn may proceed with a System Project and the payment of the costs of such System Project upon the following terms and conditions:

(1) Oak Lawn shall have sought approval of such System Project and related financing, if financing is contemplated, in accordance with the other terms and conditions of this Agreement and shall not have received the necessary consent (either Executive Consent Obtained or Corporate Consent Obtained, as applicable) to such System Project or to the related issuance of Future Series Bonds.

(2) Oak Lawn shall notify the Municipal Customers of its intent to acquire and construct the System Project notwithstanding that consent has not been obtained.

(3) Oak Lawn shall construct and operate the System Project in such a manner as shall not have any adverse impact on or be detrimental to its ability to provide Chicago Water to all the Municipal Customers as required by this Agreement.

(4) The cost of such System Project shall be borne by Oak Lawn itself or by Oak Lawn and such other persons as may agree to pay for all or a portion of same pursuant to payments which are to be made either by a source of funds other than revenues of a Municipal Customer Water System (such as cash on hand not derived from Regional System Revenues or the proceeds of general obligation bonds) or, if payable from revenues of a Municipal Customer Water System, such payments are wholly subordinated to all payments of such Municipal Customer due under the terms of this Agreement.

Section 5. Limitation of Use of Oak Lawn Regional Water System. Without Executive Consent Obtained of the Municipal Customers affected by the proposed retail sales, Oak Lawn shall not engage in retail sales or distribution of Chicago Water to any residents or customers of (a) the Municipal Customers (except for customers of the Oak Lawn Retail Water System) or (b) the Municipal Customers' customers.

Section 6. Water Supply.

A. Serve and Purchase Full Water Requirements; Exceptions. Subject to the provisions stated in this Agreement, each Municipal Customer agrees to purchase from Oak Lawn, and Oak Lawn agrees to sell to such Municipal Customer, an amount of Chicago Water necessary to serve its Full Water Requirements; *provided, however,* that Oak Lawn's obligation to each Municipal Customer to deliver Chicago Water hereunder shall be limited as follows: (1) prior to the completion of construction of the 2013 Regional System Improvements, the amount of Chicago Water to be delivered to any Municipal Customer shall be subject to the limitations of the existing Oak Lawn Regional Water System; (2) for all Municipal Customers, to a maximum annual amount

determined on the basis of the then Current Year Allocations of such Municipal Customer and any wholesale customer of such Municipal Customer; and (3) for all Municipal Customers, to a maximum daily amount not in excess of such Municipal Customer's Daily Peaking Factor. The Parties understand and agree that the Oak Lawn Regional Water System may likewise serve the Oak Lawn Southeast System, as described above. In the event that due to limitations of the Lake Michigan Water allocations by IDNR or Oak Lawn Regional Water System incapacities, the Full Water Requirements of a Municipal Customer are not able to be served, Municipal Customers may seek an alternate source of supply of water to provide the difference between what the Oak Lawn Regional Water System is capable of providing, taking into account such IDNR allocations, and Full Water Requirements. The Oak Lawn Regional Water System incapacities giving rise to the ability of Municipal Customers to seek an alternate source of supply of water must be evidenced by either (a) express acknowledgement by Oak Lawn or (b) failure or inability of the Oak Lawn Regional System to deliver the Full Water Requirements to a Municipal Customer for not less than ten (10) days a month for three (3) consecutive months, which failure or inability is not due to (i) a break or damage to the Oak Lawn Regional Water System which is being repaired or (ii) construction or reconstruction within the Oak Lawn Regional Water System pursuant to the Asset Management Program.

B. Continuous Water Supply. Oak Lawn undertakes to use reasonable care and diligence to provide a continuous supply of Chicago Water as herein provided for, but reserves the right at any time to turn off temporarily the Chicago Water in its mains for emergency and maintenance purposes. Oak Lawn shall give to the Municipal Customers notice not less than fourteen (14) days in advance of any such turn-off, except that in emergencies it shall give notice which is reasonable under the particular circumstances of any turn-off for emergency purposes. If, at any time during the term of the Agreement, the Total Regional System Design Capacity Available, as set forth in *Exhibit "D"*, is demonstrated to be less than that set forth in *Exhibit "D"*, based upon the methodology set forth for long-term capacity in *Exhibit "L"*, then, Oak Lawn shall immediately undertake a system design capacity study to determine the cause of the deficiency. Such study shall be performed by an independent consulting engineer and the result of the study, including its recommendations, shall be provided to the Municipal Customers for review and comment. If the deficiency is the result of an operational or maintenance issue requiring no improvement to the Oak Lawn Regional Water System, Oak Lawn shall correct the cause of the deficiency as soon as practicable and demonstrate that the System design capacity has been restored. If the deficiency requires further improvements to the Oak Lawn Regional Water System to correct, Oak Lawn shall coordinate and provide such improvements as soon as practicable. Such improvements shall be deemed a "System Project" and shall generally entail: (1) commencing a study of the improvement needed; (2) preparing a design (*i.e.*, plans and specifications) of the improvement; and (3) obtaining funding pursuant to this Agreement and thereupon constructing the improvement. In addition to any other rights under this Agreement, the Municipal Customers shall have the right to review and comment on the proposed System Project and all related studies and designs prepared by or for Oak Lawn.

C. Delivery of Additional Water. Each Municipal Customer may request from Oak Lawn the use of Available Capacity during the term of this Agreement. Such a request shall be for up to a one-year period as specified in the request. Such use shall not be unreasonably denied by Oak Lawn, *provided that*: (1) an independent consulting engineer selected by Oak Lawn

has determined that Available Capacity exists using the methodology set forth in *Exhibit "L"* and such determination has been approved by the Executive Consent Obtained of Municipal Customers having not less than seventy-five percent (75%) of the 2030 Allocations; (2) the requesting Municipal Customer's use of Available Capacity will not cause the Municipal Customer to exceed its Current Year Allocation for the year in which the request is made, except to the extent permitted by law; (3) the requesting Municipal Customer's use of Available Capacity will not adversely affect Oak Lawn's ability to deliver Chicago Water to other Municipal Customers as required by contracts with those Municipal Customers; and (4) the requesting Municipal Customer's use of Available Capacity does not compromise Oak Lawn's ability to comply with the terms and conditions of the Chicago-Oak Lawn Agreement. The Parties understand that the use of Available Capacity, if granted, may occasionally cause a Municipal Customer to exceed the Daily Peaking Factor. Such excess use will not be construed as a breach of this Agreement *provided* the aforementioned Available Capacity use provisions have been satisfied. Municipal Customers shall compensate Oak Lawn for the use of Available Capacity in accordance with Section 15.

D. Curtailment. If it becomes necessary for Oak Lawn to limit its delivery of Chicago Water to Municipal Customers or Future Water Customers for any reason, then each Municipal Customer, and each Future Water Customer whose water supply agreement provides for a pro rata share in the event of curtailment, shall be entitled to receive a share of Chicago Water during such period of curtailment as determined by the ratio of its Current Year Allocation (or such lesser amount to which such Customer may be entitled pursuant to its water supply agreements) to the sum of the Current Year Allocations (or such lesser amount to which such Customer may be entitled pursuant to its water supply agreements) of all such entities entitled to Chicago Water.

E. Pressure at Delivery. Oak Lawn shall supply Chicago Water to the Municipal Customers at their respective Points of Delivery at a pressure sufficient to deliver the Chicago Water and, from and after the date the 2013 Regional System Improvements are Substantially Complete and Operational, the pressure at the meter at each Point of Delivery shall in no event be less than 20 pounds per square inch, except when permitted by federal or state law. Oak Lawn shall not provide Chicago Water at a pressure such that it may cause damage to the Municipal Customers' Water Systems.

F. Certain Water Quality Provisions. Oak Lawn shall provide Chicago Water at each Municipal Customer Point of Delivery of a quality not less than as provided under the Chicago-Oak Lawn Agreement. If said water quality degrades below that required under the Chicago-Oak Lawn Agreement and a means of correction is available to Oak Lawn as a result of the completion of the 2013 Regional System Improvements, Oak Lawn shall use all commercially reasonable efforts to correct the degradation. If said water quality degrades below that required by the Chicago-Oak Lawn Agreement and no means of correction is available to Oak Lawn to correct the degradation without further improvement to the Oak Lawn Regional Water System, Oak Lawn shall coordinate and provide such improvements as soon as practicable. Such improvements shall be deemed a "System Project" and shall generally entail: (1) commencing a study of the improvement needed; (2) preparing a design (*i.e.*, plans and specifications) of the improvement; and (3) obtaining funding pursuant to this Agreement and thereupon constructing the improvement. In addition to any other rights under this Agreement, the Southwest System

Customers shall have the right to review and comment on the proposed System Project and all related studies and designs prepared by or for Oak Lawn.

Section 7. Certain Permitted Service and Connections.

A. Municipal Customer Service and Connections Generally. Each Municipal Customer shall have the exclusive right to serve and distribute Chicago Water to: (1) its current customers, whether or not within its corporate limits; (2) future customers on land presently located within its limits; (3) future customers on land lawfully annexed by it; and (4) future customers not within its corporate limits, subject to the provisions of the Chicago-Oak Lawn Agreement. Municipal Customers shall have the right to maintain and use existing wells or other alternate sources of water to meet emergency needs when Oak Lawn is not able to provide Full Water Requirements to such Municipal Customers. Municipal Customers shall have the right to maintain and use emergency connections with adjacent communities for mutual assistance purposes. The emergency well or alternate supply usage or emergency connections shall not be used without notifying Oak Lawn within forty-eight (48) hours after a required use.

B. Wholesale Service and Connections Recognized. Oak Lawn and all the Municipal Customers expressly recognize the full right and privilege of (i) Tinley Park through the Tinley Park Branch System to serve Tinley Park, Mokena, New Lenox and the Illinois American Water Company within its service area in the Village of Orland Hills and vicinity within the Current Year Allocations provided, (ii) Orland Park through its Municipal Customer Water System to serve the Illinois American Water Company within its service area in the area commonly known as “Alpine Heights” and vicinity within the Current Year Allocations provided, and (iii) Tinley Park or Mokena through its respective Municipal Customer Water System to serve the Illinois American Water Company within its service area in the area commonly known as “Arbury Hills” and vicinity within the Current Year Allocations provided.

C. Oak Lawn Service and Connections. Subject to the provisions of Sections 7.A and 7.B and Section 6.A, Oak Lawn shall have the sole and exclusive right to service the Municipal Customers and Future Water Customers, not located within any Municipal Customer’s corporate limits, through the Oak Lawn Regional Water System; *provided, however*, that with respect to such Future Water Customers which are not within the Oak Lawn Southeast System, Oak Lawn is able to adequately and fully service not only Municipal Customers’ water requirements as provided in this Agreement, but also all customers being serviced through the Oak Lawn Regional Water System at such time pursuant to such agreements as are then in place; and *provided further* that any such additional customer is to be served with facilities designed and constructed in accordance with sound engineering principles. In the event that the Southeast System Customers do not enter into the New Southeast Customer Agreements, the Municipal Customers which are Parties to this Agreement acknowledge the existence of the Oak Lawn Southeast System and the obligations of the Oak Lawn Regional Water System to deliver water for the duration of the Existing Southeast Customer Contracts. Further, upon the final expiration of such Existing Southeast Customer Contracts, as in effect at this time, said Municipal Customers acknowledge the full right of Oak Lawn to continue to serve the Oak Lawn Southeast System, subject to the municipalities which are served by the Oak Lawn Southeast System becoming, at such time, Future Water Customers as provided herein.

D. Emergency Customers. Oak Lawn may enter into mutual assistance agreements for emergency service with other suppliers of water; *provided*, that such service, if it is not limited to being provided solely from the Oak Lawn Reserved Share, shall be subject to the limitations as follows: “emergency” for purposes of this limitation shall exclude seasonal peaking requirements and shall generally be limited to system breaks, temporary loss of supply, or similar events; and, *provided, further*, if such emergency service results in any curtailment of service to the Southwest System Customers, such emergency service shall not continue beyond five (5) days during the period from May 15 and ending September 15 of any year or ten (10) days during any other period. Oak Lawn may also provide emergency service without meeting the requirements or beyond the limits set forth in this paragraph pursuant to Executive Consent Obtained. For purposes of this paragraph, Executive Consent Obtained shall be provided or denied within forty-eight (48) hours after notice from Oak Lawn. For purposes of this section, notice to a Municipal Customer shall be by telephone and confirmed in writing immediately by notice pursuant to Section 34.

E. Other Service by Amendment. Except as otherwise provided in this Agreement, upon written amendment to this Agreement, Municipal Customers may service other municipalities or private entities, not located within their corporate limits, through or with Chicago Water supplied by the Oak Lawn Regional Water System, upon such terms and conditions as may be agreed to by Oak Lawn and each (100%) of the Municipal Customers affected.

Section 8. Certain Mutual Storage, Operation and Conservation Provisions; Asset Management Program; Certain System Project and Related Financing Permitted.

A. Municipal Customer Storage Requirements. Each Municipal Customer shall maintain and operate, at its own cost and expense, facilities for the storage of Chicago Water sufficient in the aggregate to store not less than two (2) times its respective average day’s use of water (calculated on an average annual daily basis).

B. Operation of Municipal Customer Water Systems. Municipal Customers agree to operate their respective Municipal Customer Water System from the Point of Delivery on to the Municipal Customer’s customers in such a manner as to not place the Oak Lawn Regional Water System in jeopardy of failing to meet: (1) the regulations of any agency or governmental authority having jurisdiction in the operation of public water supplies; or (2) the commitments to other Municipal Customers and to Future Water Customers and to Chicago (except when such commitments could be in violation or derogation of Oak Lawn’s obligations to Municipal Customer’s rights under this Agreement). If a Municipal Customer shall fail to operate its respective Municipal Customer Water System as described in this Section 8.B after ninety (90) days written notice to do so by Oak Lawn, or in the case of an emergency, such reasonable notice as may be given under the circumstances, Oak Lawn may, in the reasonable discretion of Oak Lawn, (a) turn-off or curtail its delivery of Chicago Water to said Municipal Customer or (b) repair or replace, but is not obligated to, the appropriate parts of said Municipal Customer Water System, as is necessary for the proper operation of the Oak Lawn Regional Water System, and the cost of such repairs or replacement, including engineering costs, attorney’s fees, and permitting fees relating thereto, shall be charged to and paid by said Municipal Customer. No such non-emergency repair or replacement of a Municipal Customer Water System shall be performed by Oak Lawn without first obtaining all necessary permits from entities with jurisdiction over the

proposed repair or replacement, which permits, if to be issued by such Municipal Customer, shall not be unreasonably withheld. Upon request from Oak Lawn, each Municipal Customer will provide to Oak Lawn access to SCADA system near real-time data, including daily and weekly tallies, sufficient to allow monitoring of operating conditions within its Municipal Customer Water System (and, for Municipal Customers that provide Chicago Water to wholesale customers, further, of the operating conditions of the water systems of each of such wholesale Chicago Water customers), which access to such data shall be provided not later than one year after such request but in no event prior to the date which is one year after the 2013 Regional System Improvements are Substantially Complete and Operational.

C. Notice in Certain Events Regarding Water Supply. Municipal Customers also agree to notify Oak Lawn as promptly as possible of all emergency and other conditions which may directly or indirectly affect the quantity or the quality of the Chicago Water received hereunder or the Oak Lawn Regional Water System.

D. Conservation. Each Municipal Customer further agrees to take measures to conserve and prevent waste of water and not to exceed its respective Daily Peaking Factor, except as provided in Section 6.C of this Agreement.

E. In General—Operation of Oak Lawn Regional Water System. Oak Lawn will take all steps necessary so that the Oak Lawn Regional Water System may at all times be operated advantageously and efficiently, and in compliance with all applicable federal, state and local laws, codes, ordinances, rules and regulations. To that end, Oak Lawn shall take steps to incorporate best practices for the operation, administration and management of the Oak Lawn Regional Water System which include, without limitation, the following:

(1) Maintenance of the Oak Lawn Regional Water System in good working order, completing necessary repairs in a manner consistent with good utility practices, and maintaining proper documentation of same.

(2) Exercise all valves in the Oak Lawn Regional Water System not less than once every twenty-four (24) months, and provide a report or other suitable documentation to the Municipal Customers demonstrating completion and results after implementation of the 2013 Regional Water System Improvements.

(3) Response to emergency situations involving the Oak Lawn Regional Water System, such as main breaks, pump failures and other emergency situations, immediately upon identifying the emergency, and maintenance of an adequate inventory of spare parts and materials, such as pipes and valves, as well as contractors ready and available to respond on short notice to ensure completion of necessary repairs in a timely manner.

(4) Not later than one year after the 2013 Regional System Improvements are Substantially Complete and Operational, provide access to SCADA system near real-time data, including daily and weekly tallies, sufficient to allow monitoring of operating conditions of the Oak Lawn Regional Water System.

(5) Provide the following reports to the Municipal Customers upon request: (i) daily flow reports, and (ii) such annual, monthly and other flow and usage reports normally produced by Oak Lawn; *provided, however*, that this provision is not intended to require Oak Lawn to create reports that it does not regularly produce.

(6) Conduct a leak detection survey of not less than ten (10%) percent of the Oak Lawn Regional Water System on an annual basis to determine water losses in the System and identify areas of the Oak Lawn Regional Water System requiring improvements to resolve leakage, including provision of a written report to the Municipal Customers describing all findings and recommendations from the surveys.

(7) Conduct regular monitoring and testing of all cathodic protection systems used as part of the Oak Lawn Regional Water System, and identify where operating conditions and/or levels of protection may have changed, with copies of reports of such testing and analysis to be provided to the Municipal Customers upon request, when available.

F. Asset Management and Asset Management Program. Oak Lawn will identify and implement best management practices and standards for the Oak Lawn Regional Water System. To that end, within two (2) years after the Effective Date, Oak Lawn will provide an Asset Management Program. The Asset Management Program shall thereafter be updated biennially. To be effective for the provisions of this Agreement, the Asset Management Program and any annual updates must be approved by Executive Consent Obtained. Upon such consent, Oak Lawn shall implement such Asset Management Program.

Section 9. Measuring Equipment.

A. Measuring Supply to Municipal Customers. Oak Lawn shall assume ownership of, as part of the Oak Lawn Regional Water System, and each Municipal Customer shall convey by bill of sale to Oak Lawn for use in the Oak Lawn Regional Water System, the existing Meters, Valves and Controls for water delivery at the Points of Delivery to Oak Forest, Orland Park and Tinley Park North and Tinley Park South. Oak Lawn shall, from and after the Effective Date of this Agreement, furnish, install, operate, maintain, repair and replace at each Municipal Customer's respective sole cost and expense at the Point of Delivery the necessary Meters, Valves and Controls, which shall remain the property of the Oak Lawn Regional Water System. The Meters, Valves and Controls shall be of a type meeting the standards of the American Water Works Association for properly measuring the quantity of Chicago Water delivered under this Agreement. Such Meters, Valves and Controls shall be located upon land provided by or available to each Municipal Customer pursuant to Section 11. Both Oak Lawn and each Municipal Customer, respectively, shall have access to such Meters, Valves and Controls for examination and inspection at all reasonable times, *provided* that Oak Lawn's access to the Meters, Valves and Controls shall be with prior notice to, and supervision by, personnel of the Municipal Customer. The reading for billing purposes, calibration and adjustment thereof shall be performed only by the employees or agents of Oak Lawn and only with Oak Lawn's authorization.

B. Annual Calibration. Not less than once in each Fiscal Year, Oak Lawn shall (1) for meters that can be calibrated in place, calibrate its meters in the presence of respective representatives of the Municipal Customers, and such Parties shall jointly observe any adjustments which are made to the meters in case any adjustments shall be necessary, and (2) for meters that must be removed for calibration, coordinate with the Municipal Customer affected as to the time for such removal and calibration, identify to the Municipal Customer the testing company Oak Lawn proposes to use for the calibration, and provide to the Municipal Customer a copy of any calibration reports and documentation showing the calibration results and any repairs or adjustments that are made. Except as otherwise expressly provided, the measurement of Chicago Water for the purpose of this Agreement shall be solely by Oak Lawn's meters located at the Points of Delivery.

C. Check Meters. Each Municipal Customer may, at its option, require that Oak Lawn furnish and install a check meter at the expense of the Oak Lawn Regional Water System, which expense shall be deemed a Transmission Main Maintenance Cost, in the event that Oak Lawn elects to modify the configuration of the Meters, Valves and Controls at that Municipal Customer's Point of Delivery as such Meters, Valves and Controls existed as of the Effective Date. Any such meter installed for a Municipal Customer will, upon acceptance by the Customer, be owned and operated by that Municipal Customer, provided each check meter does not interfere with the accuracy of the Oak Lawn meter. All check meters shall be of a type meeting the standards of the American Water Works Association for properly measuring the quantity of Chicago Water and shall be subject to inspection and examination by any employee or agent of Oak Lawn, but the calibration and adjustment thereof shall be only by the Municipal Customer, except during any period when a check meter may be used under the provisions of this Section for measuring the amount of Chicago Water delivered to the Municipal Customer, in which case such meters shall be calibrated by Oak Lawn in the presence of respective representatives of such Party and the Parties shall jointly observe any adjustment in case any adjustment is necessary. Except as may be expressly otherwise provided or agreed, the measurement of Chicago Water for the purpose of this Agreement shall be solely by Oak Lawn's meters located at the Points of Delivery.

D. Variance. If any Party at any time observes a variation between a delivery meter and a check meter, or any other evidence of meter malfunction, such Party shall promptly notify the other affected Party and the affected Parties shall then cooperate to procure an immediate calibration test and adjustment of such meter or may request an independent testing and adjusting service, and shall jointly observe any such adjustment. Each Party shall give the other Party not less than forty-eight (48) hours notice of the time of all tests of meters so that the other Party may have a representative present. If said representative is not present at the time set in such notice, calibration and adjustment may, notwithstanding any other provision of this Section, proceed in the absence of said representative. If such test shall show any meter to be registering within two percent (2%) (plus or minus) of the correct quantity, it shall be considered accurate and the cost of all such testing shall be borne by the Party claiming the variation. If any such test shows any meter to be measuring incorrectly, (plus or minus) to any extent greater than two percent (2%) of the correct quantity, an adjustment shall be made with respect to the amount paid or to be paid to Oak Lawn for Chicago Water passing through such meter by mutual agreement between Oak Lawn and the affected Municipal Customer based upon the best data available, for a period extending back to the time when such inaccuracy began if such time is ascertainable, or for a period

extending back one-half of the time elapsed since the last date of calibration (but in no event further back than a period of six months) if such time is not ascertainable, and the costs of such testing shall be borne by the Party responsible for the Meter.

E. Notice of Testing and Calibration. Each Party shall give the other affected Party not less than forty-eight (48) hours notice of the time of all tests of meters so that the other Party may have a representative present. If said representative is not present at the time set in such notice, calibration and adjustment may, notwithstanding any other provision of this Section, proceed in the absence of said representative. Every effort shall be made to perform meter maintenance and calibration during periods that are not high water demand periods, and during which water conservation rules are not in effect.

F. Unit of Measurement. The unit of measurement for Chicago Water delivered under this Agreement shall be one thousand (1000) gallons of water, U.S. Standard Liquid Measure, and all measuring devices shall be so calibrated unless Oak Lawn and the Municipal Customers agree otherwise in writing. Should it become necessary or desirable to use cubic feet as the unit of measurement, the basis of conversion shall be that 7.48052 gallons is equivalent to one cubic foot.

G. Meter Malfunctions. If, for any reason, any meter is out of service or in disrepair so that the amount of Chicago Water delivered cannot be ascertained or computed from the reading thereof, then the Chicago Water delivered during the period such meter is out of service or in disrepair shall be deemed to be the registration of the check meter if one has been installed and is measuring accurately, or, in the event that no check meter has been installed or the check meter is registering inaccurately, shall be estimated:

(i) By correcting the error if the percentage of the error is ascertainable by calibration tests or mathematical calculations; or

(ii) If the error is not ascertainable by calibration tests or mathematical calculations, by estimating the quantity of delivery by considering deliveries during preceding periods under similar conditions when the meter or meters were registering accurately.

Section 10. Ownership.

A. Title to Chicago Water. Title to Chicago Water supplied hereunder shall remain with Oak Lawn to each Point of Delivery and, upon passing into the respective Municipal Customer Water System at the Point of Delivery, title to the Chicago Water shall pass to that Municipal Customer.

B. Oak Lawn Ownership. The ownership of the Oak Lawn Regional Water System including all System Projects is and shall be vested in Oak Lawn (except for the Orland Spur One Main and the Orland Spur Two Main, which shall be owned by Orland Park) and responsibility for the maintenance and repair of the Oak Lawn Regional Water System shall be solely that of Oak Lawn.

Section 11. Transfer of Property Rights.

A. Conveyance of Southwest Customer Easements. The Southwest Customers agree to grant or provide the following interests in land or property in connection with the following elements of the Oak Lawn Regional Water System, to the extent that these elements are on land or property owned by the particular Southwest Customer:

(1) Oak Forest, Orland Park and Tinley Park shall grant to Oak Lawn such easements, licenses or rights of access for Oak Lawn to Meters, Valves and Controls and other related facilities to be operated by Oak Lawn pursuant to Section 9.A as are reasonably necessary for Oak Lawn's operation of the Oak Lawn Regional Water System, within ninety (90) days after Oak Lawn provides notice and a proposed form of grant to the affected Southwest System Customer; and

(2) the affected Southwest System Customers shall grant to Oak Lawn the necessary easements, licenses, permits or rights of access for those portions of the 2013 Regional System Improvements described in the nine bid packages listed in *Exhibit "C"*, within ninety (90) days after Oak Lawn provides notice and a proposed form of grant to the affected Southwest System Customer for a particular bid package for which the easement, license, permit or right of access is necessary; and

(3) an easement, license, permit or right of access for an existing element of the Oak Lawn Regional Water System that Oak Lawn discovers is in place as of July 1, 2013 on land or property owned by a Southwest System Customer, within one hundred eighty (180) days after Oak Lawn provides a written request pursuant to notice and a proposed form of grant to the affected Southwest System Customer for that particular element that is fully described in the notice, and for which there is no easement, license, permit or right of access in place as of the date of the notice.

Any easement, license, permit or right of access requested by Oak Lawn pursuant to this Section shall not require the Southwest System Customer to relocate, alter or modify existing improvements or facilities in any way that would disrupt the continued operations and purposes of that Southwest System Customer. Oak Lawn agrees that any costs and expenses (such as legal or engineering fees) incurred by the Southwest System Customers in connection with the provision of any such easements, licenses or other rights to Oak Lawn shall be reimbursed by Oak Lawn as a cost of the Oak Lawn Regional Water System. The Southwest System Customers agree to reasonably assist (at the expense of the Oak Lawn Regional Water System) with the acquisition of other easements, licenses or rights of access on land or property located within their respective boundaries, upon written request from Oak Lawn that identifies a specific parcel of land or property.

B. Acquisition of Property. Oak Lawn shall, immediately after the Effective Date of this Agreement, commence all actions necessary to acquire all easements, licenses, and rights of access not already owned by Oak Lawn necessary for construction and operation of the 2013 Regional System Improvements or for continued effective operation of the Oak Lawn Regional Water System and to fulfill the requirements of Section 13. All such easements, licenses, and rights of

access shall be obtained by Oak Lawn at Oak Lawn's expense as a cost of the Oak Lawn Regional Water System.

C. License to Use the Orland Spur One Main. For the term of this Agreement, Orland Park hereby grants to Oak Lawn a license to operate, use, maintain, test, inspect, repair, remove, and replace, together with all reasonable rights of ingress and egress necessary for the exercise of the license, as a part of and an expense of the Oak Lawn Regional Water System, the Orland Spur One Main. The Orland Spur One Main is owned by Orland Park and such ownership shall continue to be held by Orland Park. Orland Park reserves the right (i) to test and inspect the Orland Spur One Main at any time without notice to Oak Lawn, and (ii) to repair, or to remove and replace, the Orland Spur One Main following notice to Oak Lawn and Oak Lawn's failure to complete the necessary repair, or removal and replacement, following ninety (90) days notice to Oak Lawn of the need for the repair, or removal and replacement. Orland Park will submit evidence of all costs and expenses incurred in connection with any such repair, or removal and replacement, and such costs and expenses shall be reimbursed by Oak Lawn to Orland Park and such costs and expenses shall be treated by Oak Lawn as costs and expenses of Oak Lawn Regional Water System.

D. (1) Construction of the Orland Spur Two Main. As part of the 2013 Regional Water System Improvements, Oak Lawn will design, construct and install the Orland Spur Two Main, the cost of which will be borne and paid for by Orland Park as part of Orland Park's share of the Capital Costs and Charges. The Orland Spur Two Main shall be designed and constructed in accordance with Oak Lawn's specifications, including but not limited to the flow meter configuration and the corrosion control system. Orland Park shall be named as the owner on any permit or easement related to the Orland Spur Two Main. *(2) Alternate Pipe Size Election.* Oak Lawn shall include alternate bid items in the bid package for the Orland Spur Two Main for alternate pipe sizes for the Main that are larger than 24-inches in diameter as requested by Orland Park. Oak Lawn shall notify Orland Park of the prices received for the alternate pipe sizes; in the event that Orland Park notifies Oak Lawn that Orland Park elects to have the Main be constructed in one of the alternate pipe sizes, Oak Lawn shall include the alternate pipe size elected by Orland Park in the contract for that bid package. Oak Lawn shall include the additional cost of construction of the Main resulting from the election of the alternate pipe size in the relevant bid package which shall be financed by the issuance of New Series Bonds. Orland Park shall be allocated that portion of the bid package attributable to the additional cost of the alternate pipe size and shall be directly billed for a pro-rata percentage of the debt service due on the New Series Bonds issued for said bid package. *(3) Conveyance of and License to Use the Orland Spur Two Main.* Upon completion and final acceptance, Oak Lawn will convey the Orland Spur Two Main to Orland Park by a bill of sale from Oak Lawn to Orland Park. After completion of that conveyance, for the remaining term of this Agreement: (i) Orland Park hereby grants to Oak Lawn a license to operate, use, maintain, test, inspect, repair, remove, and replace, together with all reasonable rights of ingress and egress necessary for the exercise of the license, as a part of and an expense of the Oak Lawn Regional Water System, the Orland Spur Two Main; (ii) the Orland Spur Two Main will be owned by Orland Park and such ownership shall continue to be held by Orland Park; and (iii) Orland Park reserves the right (a) to test and inspect the Orland Spur Two Main at any time without notice to Oak Lawn, and (b) to repair, or to remove and replace, the Orland Spur Two Main following notice to Oak Lawn and Oak Lawn's failure to complete the necessary repair, or removal and replacement, following ninety (90) days notice to Oak Lawn of the need for the

repair, or removal and replacement. Orland Park will submit evidence of all costs and expenses incurred in connection with any such repair, or removal and replacement, and such costs and expenses shall be reimbursed by Oak Lawn to Orland Park and such costs and expenses shall be treated by Oak Lawn as costs and expenses of Oak Lawn Regional Water System.

E. Palos Hills Connection and Pump Station Building. As part of the 2013 Regional Water System Improvements, Oak Lawn will design, construct and install the Palos Hills Connection and construct and install a new Pump Station Building, the cost of which will be borne and paid for by Palos Hills as part of Palos Hills' share of the Capital Costs and Charges up to the amount of \$2,666,670. Oak Lawn shall include any costs in excess \$2,666,670 for the construction of the Connection and Pump Station Building in Bid Package 8 which shall be financed by the issuance of New Series Bonds. Palos Hills shall be allocated that portion of Bid Package 8 in excess \$2,666,670 and shall be directly billed for a pro-rata percentage of the debt service due on the New Series Bonds issued for Bid Package 8. Upon completion and final acceptance, Oak Lawn is to convey the Pump Station Building to Palos Hills by a bill of sale from Oak Lawn to Palos Hills; *provided, however*, that Oak Lawn shall retain ownership of the piping and all appurtenances to the downstream flange of the flow meter and that Palos Hills shall grant Oak Lawn right of access to the Pump Station Building for the purpose of maintaining said piping and appurtenances. After completion of that conveyance, for the remaining term of this Agreement, the Pump Station Building will be owned by Palos Hills and such ownership shall continue to be held by Palos Hills and Oak Lawn shall have no right or obligation to operate, use or maintain the Pump Station Building except for said piping and appurtenances described herein. Palos Hills shall be named as the owner on any permit or easement related to the Pump Station Building.

Section 12. Construction by Municipal Customers. The Municipal Customers will with all practicable speed, prepare and complete plans for the construction of their respective Municipal Customer Improvements. Each Municipal Customer will ensure that its respective (1) Municipal Customer Improvements and (2) Future Improvements to its respective Municipal Customer Water System performed by the Municipal Customer, shall be made in accordance with sound engineering principles, constructed in a reasonable and workmanlike manner and designed in a manner compatible with the Oak Lawn Regional Water System to allow effective delivery of Chicago Water to such Municipal Customer. Oak Lawn shall have the right, but not the obligation, to review and comment on all studies, construction drawings, and contract documents for the construction of said Municipal Customers Improvements and Future Improvements. Oak Lawn's approval shall not be unreasonably withheld. Upon completion, the Municipal Customer Improvements shall be deemed part of the respective Municipal Customer Water System.

Section 13. Coordination and Completion of the 2013 Regional System Improvements and Future Projects.

A. 2013 Regional System Improvements. Oak Lawn will construct the 2013 Regional System Improvements with due diligence. Oak Lawn will undertake to work and cooperate with the Municipal Customers to establish construction schedules which will efficiently cause acquisition and construction of the System Projects that comprise the 2013 Regional System Improvements so as to meet the needs of the Municipal Customers with minimal disruptions of service, and the Municipal Customers shall likewise work and cooperate with Oak Lawn to such

end and to provide such facilities within each respective Municipal Customer Water System as will permit the Oak Lawn Regional Water System to efficiently serve such needs. Subject to *force majeure*, Oak Lawn will endeavor to complete the 2013 Regional System Improvements by December 31, 2025. Further, Oak Lawn shall proceed with due diligence to construct the 2013 Regional System Improvements. Oak Lawn shall not change any route approved herein for the 2013 Regional System Improvements to a route which is not through Cook County Forest Preserve District land without Corporate Consent Obtained. Further, beginning with Bid Package 4A and for all subsequent Bid Packages, Executive Consent Obtained is required to award a Bid Package, approve engineering (design and construction) contracts for such Bid Package and approve any additional engineering requirements exceeding \$5,000 per Bid Package.

B. Contracts. All contracts and agreements for work contemplated by this Agreement shall be awarded by Oak Lawn pursuant to the procurement requirements of Oak Lawn's municipal code and in compliance with any procurement requirements of the IEPA (as and if applicable), except where another process is proposed by Oak Lawn and approved by two-thirds of Oak Lawn's corporate authorities. Oak Lawn shall include in all contracts and agreements for the design and construction of the 2013 Regional System Improvements and any future System Projects such terms and conditions that will provide reasonable and sufficient protection for Oak Lawn and the Municipal Customers to ensure the prompt and timely completion of the 2013 Regional System Improvements and future System Projects, as applicable. Such terms and conditions shall include, without limitation, submission of work schedules for review and approval, performance bonds and labor and material payment bonds from sureties with appropriate ratings and assets for the specific project, and liquidated damages.

C. Palos Park Option to Upgrade the Size of Its System Connection Main. The Southwest System Customers acknowledge that, as part of the 2013 Regional Water System Improvements, Oak Lawn will design, construct and install the transmission main that connects the West Side Transmission Main to the Palos Park Point of Delivery (the "*Palos Park System Connection Main*"), the cost of which will be borne and paid for by Palos Park as part of Palos Park's share of the Capital Costs and Charges. Oak Lawn shall include alternate bid items in the bid package for the Palos Park System Connection Main for alternate pipe sizes for the Palos Park System Connection Main that are larger than 10-inches in diameter as requested by Palos Park. Oak Lawn shall notify Palos Park of the prices received for the alternate pipe sizes. In the event that Palos Park notifies Oak Lawn that Palos Park elects to have the Palos Park System Connection Main be constructed in one of the alternate pipe sizes, Oak Lawn shall include the alternate pipe size elected by Palos Park in the contract for that bid package. Within thirty (30) days after completion and final approval of the Palos Park System Connection Main and the submission of an invoice by Oak Lawn to Palos Park therefor, Palos Park is to reimburse Oak Lawn for the additional cost of construction of the Palos Park System Connection Main resulting from the election of the alternate pipe size, and Palos Park is not to pay any additional amount as a part of the Capital Costs and Charges due to the election of the alternate pipe size. Alternatively, at the request of Palos Park, Oak Lawn shall include the additional cost of construction of the Palos Park System Connection Main resulting from the election of the alternate pipe size in the relevant bid package which shall be financed by the issuance of New Series Bonds. Palos Park shall be allocated that portion of the bid package attributable to the additional cost of the alternate pipe size

and shall be directly billed for a pro-rata percentage of the debt service due on the New Series Bonds issued for said bid package.

D. Realignment of Transmission Main. Oak Lawn and the Southwest System Customers agree to a realignment of the Transmission Main for Bid Package 7A (Cross-Town Connection to Booster Station 2) and Bid Package 7B (Orland Park Spur Two Main), such that the intersection of the improvements financed by Bid Package 7A and Bid Package 7B occurs at a point south of 151st Street as shown on *Exhibit C-1* attached hereto (with such further changes or modifications as approved by Executive Consent Obtained). Orland Park shall be allocated \$812,800 of any additional costs resulting from this realignment (including 36-inches of the 60-inch pipe running south of 151st Street along the Com-Ed corridor, engineering costs, construction services, permit fees and easements) and shall be directly billed for a pro-rata percentage of the debt service due on the New Series Bonds issued for said bid package. Any additional costs as a result of the realignment in excess of \$812,800 shall be paid by the Municipal Customers as a part of the Capital Costs and Charges.

Section 14. Air Gap. Each Municipal Customer shall install and maintain an Oak Lawn approved backflow prevention device immediately downstream of the Point of Delivery. Such device (or devices) shall take the form of an air gap. Air gap based backflow prevention shall provide a minimum of six (6) inches between the highest possible receiving water level in the Municipal Customer's Water System and the point of discharge to the air gap. No water utilization equipment, service connections, etc., shall be connected to the Municipal Customer's Water System between the Point of Delivery and the Oak Lawn approved backflow prevention device.

Section 15. Price and Terms of Payment; Certain Limits on Rates and Charges; True Up; Recognition of Lien of Bonds. In the periods as indicated, each of the Municipal Customers shall pay to Oak Lawn its respective share of Aggregate Costs and other amounts due upon the terms set forth. In each Fiscal Year, Oak Lawn shall provide a summary of Aggregate Costs to each of the Municipal Customers in the Aggregate Costs Template included in *Exhibit "Q"*, or such other format as may be approved by Executive Consent Obtained.

A. Operation and Maintenance Costs. All elements of Operation and Maintenance Costs shall be due and payable monthly and shall be in default if not paid within thirty (30) days after the due date.

(1) Each Municipal Customer shall pay an amount equal to the amount payable by the Oak Lawn Regional Water System to Chicago for the month pursuant to the Chicago-Oak Lawn Agreement or any successor agreement for the measured amount of Chicago Water delivered by Oak Lawn to that Municipal Customer at its Point or Points of Delivery. Such amount shall be stated in a dollar cost per 1,000 gallons of Chicago Water delivered times the gallons so delivered.

(2) Each Municipal Customer shall pay an amount equal to the amount of Electricity Costs incurred for the month by the Oak Lawn Regional Water System times such Municipal Customer's share of such costs as shown in *Exhibit "F"*. Such amount shall be stated in a dollar cost per 1,000 gallons of Chicago Water delivered times the

gallons so delivered, and, except upon Executive Consent Obtained, shall not be adjusted during the course of a given Fiscal Year from the rate in effect at the start of such Fiscal Year or, if a rate increase is known to become effective at the start of such Fiscal Year, then also giving effect to such rate increase as of its effective date.

(3) Each Municipal Customer shall pay an amount equal to the amount of Pump Station Maintenance Costs required for the Fiscal Year by the Oak Lawn Regional Water System times such Municipal Customer's share of such costs as shown in *Exhibit "G"*. Such amount shall be stated in a dollar cost per 1,000 gallons of Chicago Water delivered times the gallons so delivered, and, except upon Executive Consent Obtained, such amount shall not be adjusted during the course of a given Fiscal Year.

(4) Each Municipal Customer shall pay an amount equal to the amount of Transmission Main Maintenance Costs required for the Fiscal Year by the Oak Lawn Regional Water System times such Municipal Customer's share of such costs as shown in *Exhibit "H"*. Such amount shall be stated in a dollar cost per 1,000 gallons of Chicago Water delivered times the gallons so delivered, and, except upon Executive Consent Obtained, such amount shall not be adjusted during the course of a given Fiscal Year.

(5) Each Municipal Customer shall pay an amount equal to the System Operations Costs required for the Fiscal Year by the Oak Lawn Regional Water System at the Common Usage Rate, and, except upon Executive Consent Obtained, such rate shall not be adjusted during the course of a given Fiscal Year from the rate in effect at the start of such Fiscal Year.

B. Capital Costs and Charges. All elements of Capital Costs and Charges shall be due and payable quarterly on the last business day of the months selected by Oak Lawn as provided in Section 20.B, and shall be in default if not paid within thirty (30) days after the due date.

(1) Each Municipal Customer shall pay an amount equal to the amount of Capital Costs and Charges required for the Fiscal Year by the Oak Lawn Regional Water System as budgeted for such Fiscal Year (a) divided by four to represent a quarterly amount and (b) times such Municipal Customer's Proportionate Share of such costs.

(2) Each Municipal Customer shall pay its Default Proportionate Share of Default Costs Allocable to Bonds within thirty (30) days after receipt of notice from Oak Lawn that such costs are due.

C. Other Non-Operating Charges. All elements of Other Non-Operating Charges shall be due and payable monthly and shall be in default thirty (30) days after the due date.

(1) Each Municipal Customer shall pay an amount equal to the amount of all Other Non-Operating Charges required for the Fiscal Year by the Oak Lawn Regional Water System at the Common Usage Rate, and, except for payment of Default Costs Allocable to Other Aggregate Costs or upon Executive Consent Obtained, shall not be

adjusted during the course of a given Fiscal Year from the rate in effect at the start of such Fiscal Year.

(2) Other Non-Operating Charges shall include an accumulation for a reserve for the Oak Lawn Regional Water System for Operation and Maintenance Costs (the "*O&M Reserve*" which reserve is intended to provide for unforeseen increases in such costs, Default Costs, or, as provided in the proceedings for the issuance of the Bonds, to pay Bonds in the event there has been a default in the payment of Capital Costs and Charges or to pay Bonds issued in the form of a revolving line of credit). The amount so accumulated for the O&M Reserve shall not exceed the sum of (a) the cost of Chicago Water for the previous Fiscal Year divided by 12 plus (b)(i) all Operation and Maintenance Costs for the previous Fiscal Year minus said cost of Chicago Water for the previous Fiscal Year (ii) divided by 4. The required amount of the O&M Reserve shall be accumulated at the Common Usage Rate of \$0.08 (8 cents) per 1,000 gallons of Chicago Water delivered times the gallons so delivered. Draws upon said reserve shall be replenished, to the extent required, in the second Fiscal Year after such draws. Increases in the required amount of said reserve, in each year after Fiscal Year 2018, shall be fully funded, at a Common Usage Rate to be determined, in the two (2) Fiscal Years after the amount of such increase is determined. The accumulation of the O&M Reserve provided for by this provision is payable as an Other Non-Operating Charge, but the expenditure of amounts in the O&M Reserve will be for specific Operations and Maintenance Costs categories (*e.g.*, Chicago Water, Electricity Costs, or Pump Station Maintenance Costs) and Municipal Customers and Future Water Customers shall be charged for replenishment on the basis of such cost categories pursuant to the true-up provisions of Section 15.E.

Other than as set forth in this section, no Other Non-Operating Charges shall be charged by the Oak Lawn Regional Water System for reserves for Operation and Maintenance Costs.

(3) Beginning in Fiscal Year 2014, Other Non-Operating Charges shall include an amount in each Fiscal Year budgeted to produce an annual contribution (the "*Annual Contribution*") to provide funding up to full funding ("*Full Funding*") of the Renewal, Repair and Replacement Reserve Fund and thereafter for deposit to the unencumbered reserves of the Oak Lawn Regional Water System. The Annual Contribution amount shall be not less than \$750,000 for Fiscal Year 2014, and said sum of \$750,000 adjusted for any increase or decrease in the PPI in each Fiscal Year thereafter multiplied in each such year by a fraction the numerator of which is the amount of Chicago Water delivered through the Oak Lawn Regional Water System to Municipal Customers that are paying for the Annual Contribution at the Common Usage Rate and the denominator of which is all Chicago Water delivered through the Oak Lawn Regional System to Municipal Customers. The Annual Contribution may be increased pursuant to the approved Asset Management Program. Amounts in the Renewal, Repair and Replacement Reserve Fund may be expended only for Major Capital Costs or System Repairs or, as provided in the proceedings for the issuance of the Bonds, for Default Costs, or to pay Bonds in the event there has been a default in the payment of Capital Costs and Charges. Amounts in the Renewal, Repair and Replacement Reserve Fund may be expended for Major Capital Costs

only pursuant to the Asset Management Program. Amounts to be expended for System Repairs and for Major Capital Costs which in any given Fiscal Year are in excess of \$1,500,000 must be pursuant to Executive Consent Obtained. Full Funding of the Renewal, Repair and Replacement Reserve Fund shall be \$5,000,000 as measured in Fiscal Year 2014 and said sum of \$5,000,000 adjusted for any increase or decrease in PPI for each Fiscal Year thereafter. Full Funding may be increased pursuant to the Asset Management Program. Annual Contributions received at such time as the Renewal, Repair and Replacement Reserve Fund is at Full Funding will be retained in the unencumbered reserves of the Oak Lawn Regional Water System. Except in the event amounts provided for the Renewal, Repair and Replacement Reserve Fund are expended for Bond payments, the Annual Contributions are not subject to the true-up provisions of Section 15.E.

(4) Other Non-Operating Charges assessed for insurance reserve purposes shall only be made pursuant to the report and recommendation of an independent insurance consultant having a nationally recognized reputation for competence in such matters and specifying both the amount of such reserves as should be reasonably available and the rate of accumulation of same.

(5) Each Municipal Customer shall pay its share of Default Costs Allocable to Other Aggregate Costs, which share shall be as follows: (a) first, in any given Fiscal Year, Oak Lawn shall pay all Default Costs up to an amount equal to the Equitable Return received by Oak Lawn for the previous Fiscal Year and (b) thereafter, all Municipal Customers (including Oak Lawn) not in default under this Agreement shall pay a share of remaining Default Costs equal to the proportion of Chicago Water delivered to such Municipal Customer in the previous Fiscal Year to the Chicago Water delivered to all Municipal Customers (including Oak Lawn) not in default under this Agreement during such Fiscal Year.

D. Old Bonds Payments. Each Municipal Customer shall pay to Oak Lawn the amounts due on the Old Bonds at the times and in the amounts determined as required in *Exhibit "K"*.

E. True Up. On an annual basis, after adequate time is allowed for the accounting and auditing of the accounts of the Oak Lawn Regional Water System, each Municipal Customer shall receive a statement with supporting data and information of its proper share of the prior year's actual Aggregate Costs for the Regional System. Such statement shall include the amount by which each Municipal Customer may have overpaid or underpaid such actual Aggregate Costs in comparison to the approved budget for the Oak Lawn Regional Water System. Each Municipal Customer who underpaid such actual Aggregate Costs as compared to the approved budget shall make up such underpayment in the following Fiscal Year (that is, the second Fiscal Year after the Fiscal Year for which the accounting is provided due to the adequate timing that is necessary to complete such accounting). Each Municipal Customer will pay such actual Aggregate Costs classified by the particular category (*i.e.*, Operation and Maintenance Costs such as Chicago Water, Electricity Costs, Pump Station Maintenance, Transmission Line Maintenance or System Operations Costs and Capital Costs and Charges) under the same allocation method used in preparing the approved budget. Each Municipal Customer who overpaid such actual Aggregate Costs shall receive a credit in that same Fiscal Year in which underpayments would be made, such

credit being allocable by the particular category (*i.e.*, Operation and Maintenance Costs such as Chicago Water, Electricity Costs, Pump Station Maintenance, Transmission Line Maintenance or System Operations Costs and Capital Costs and Charges) under the same allocation method used in preparing the approved budget. Such makeup of underpayments or receipt of credit as provided in this Section 15.E shall be divided into twelve (12) equal monthly installments unless otherwise mutually agreed between Oak Lawn and an affected Municipal Customer, and such underpayments shall be payable as an Aggregate Cost. Such True Up as described herein is subject to approval by Executive Consent Obtained. In addition, beginning in Fiscal Year 2021, the cost of water leakage out of the Oak Lawn Regional Water System (being the variance between the amount of water billed by Chicago less the amount of water billed by the Oak Lawn Regional Water System to the Municipal Customers) for the previous year (Fiscal Year 2020) shall be paid by each Municipal Customer according to each Municipal Customer's Proportionate Share.

F. Recognition of Lien of Bonds. Each Municipal Customer acknowledges that all of the moneys paid over and held by Oak Lawn in the funds and accounts of the Oak Lawn Regional Water System, except those monies properly held for Operation and Maintenance Costs, may be subject to the prior lien of Bonds, may be pledged by Oak Lawn without limitation and in such order of priority among Bonds as Oak Lawn shall determine, and may be held by a trustee, Bondholder, or otherwise in a pledged account, and may be expended without any further action on the part of any person to pay Bonds, all as may be stated in the proceedings adopted by Oak Lawn in the authorization and issuance of Bonds.

Section 16. Payments to Chicago.

A. Timely Payments. Oak Lawn shall make timely payments to Chicago pursuant to the Chicago-Oak Lawn Agreement. Oak Lawn shall have the sole discretion as to the form of payment to Chicago for any amounts that Oak Lawn is charged under the Chicago-Oak Lawn Agreement. Any discounts, rebates or other incentives received from Chicago by Oak Lawn as a result thereof shall be the sole property of Oak Lawn and shall not affect the payment obligations of the Municipal Customers hereunder; *provided, however*, that any such discount, rebate or other incentive so received from Chicago on account of early payment to Chicago shall be shared proportionately with each Southwest System Customer and Oak Lawn which have provided early payments so as to accommodate the payments to Chicago.

B. Late Payments. In the event that Oak Lawn makes a late payment to Chicago because of circumstances within Oak Lawn's control, Oak Lawn shall pay any interest and penalty costs due to Chicago pursuant to the Chicago-Oak Lawn Agreement and such interest and penalty costs shall not be costs of the Oak Lawn Regional Water System. If the cause of the late payment is within Oak Lawn's control and Oak Lawn fails to pay Chicago for two (2) consecutive months, the Municipal Customers may pay Chicago directly for Chicago Water. In the event that Oak Lawn makes a late payment to Chicago because of a late payment by a Municipal Customer, the interest and penalty costs due to Chicago shall be paid by the Oak Lawn Regional Water System.

Section 17. Arrearages. Any Municipal Customer which does not pay its share of Aggregate Costs when due shall be in arrears to such amount ("*Arrearages*"). All Arrearages shall be payable immediately without demand and shall bear interest until paid at the rate equal to

the average rate of interest on all Bonds then outstanding plus two percent (2%) or if no Bonds are outstanding then one and a half percent (1-1/2%) per month (without compounding) or at the otherwise then highest taxable rate which may be paid by an Illinois non-home rule municipality on its bonds (of any kind), if such rate be lesser. Payments of Arrearages, when received, shall be credited pro rata to the Municipal Customers who may have paid Default Costs on account of such Arrearages as soon as practicable within the billing cycle.

Section 18. Further Covenants. The following covenants are made by all Parties to this Agreement.

A. Payments Due Hereunder are Limited to Revenues Pledged. All payments to be made under this Agreement are payable solely and only from the revenues of the Municipal Customer Water Systems, and all payments due under this Agreement shall be a continuing valid and binding obligation of each such municipality payable from the revenues derived from the operation of each such system for the period of years of this Agreement. This Agreement shall not be a debt within the meaning of any constitutional or statutory limitation under the laws of the State of Illinois. No prior appropriation shall be required before entering into this Agreement, and no appropriation shall be required to authorize payments to be made under the terms of this Agreement. Notwithstanding the provisions of this Section 18.A, the Municipal Customers and Oak Lawn are not prohibited by this Agreement from using other available funds to make the payments required by this Agreement.

B. Lien Priority of Payments Under Agreement. Each Municipal Customer shall provide in all future documents or proceedings obligating the revenues of its respective Municipal Customer Water System, and, for Oak Lawn, of the Oak Lawn Retail Water System, that all payments made under this Agreement shall be deemed and treated as operation and maintenance costs, having a first lien and priority with other such costs of such system, on the revenues of the Municipal Customer Water System or the Oak Lawn Retail Water System, as applicable.

C. Mutual Cooperation in Issuance of Obligations. Each Municipal Customer shall cooperate with Oak Lawn in the issuance of Bonds, and Oak Lawn shall cooperate with each Municipal Customer in the issuance of the Municipal Customer's bonds or other obligations of its Municipal Customer Water System. In such connection, each Municipal Customer and Oak Lawn will comply with all reasonable requests of the other and will, upon request, do as follows: (1) make available in a timely manner general and financial information about itself; (2) consent to publication and distribution of its financial information; (3) certify that general and financial information about it is accurate, does not contain an untrue statement of a material fact and does not omit to state a material fact necessary in order to make the statements in that information, in light of the circumstances under which they were made, not misleading; (4) make available certified copies of official proceedings, minutes, ordinances, resolutions, orders and documents related to this Agreement or its respective duties hereunder; (5) provide reasonable certifications to be used in a transcript of closing documents in connection with such Bonds or other obligations; and (6) provide and pay for reasonably requested opinions of counsel as to the validity of its actions taken with respect to and the binding effect of this Agreement, title to its Municipal Customer Water System, as applicable, pending or threatened litigation which could materially affect its performance hereunder, and other reasonably related opinions. Specifically, in connection with a

bond rating, bond issuance or bond continuing disclosure agreement, each Municipal Customer shall provide financial information about itself within sixty (60) days of request by Oak Lawn.

D. Segregate Revenues. Each Municipal Customer shall provide for the segregation of all revenues of its Municipal Customer Water System in such system fund or account and provide for the application of the necessary portion of the revenues for the purpose of this Agreement. An amount of funds of a Municipal Customer Water System which exceeds the obligations of such Municipal Customer hereunder may be used by that Municipal Customer for any lawful corporate purposes to the extent permitted by law. All Regional System Revenues shall be deposited in the funds and accounts of the Oak Lawn Regional Water System and used for purposes of the Oak Lawn Regional Water System. Any interest or other earnings on Regional System Revenues shall be considered Regional System Revenues.

E. General Covenant to Operate Properly. From time to time, Oak Lawn and each Municipal Customer will take steps reasonably necessary so that the Oak Lawn Retail Water System and each respective Municipal Customer Water System may at all times be operated properly and efficiently.

F. Accounting and Audit. Each Municipal Customer will make and keep proper books and accounts (separate and apart from all other records and accounts of such Municipal Customer) in which complete entries shall be made of all transactions relating to its Municipal Customer Water System, and, within two hundred ten (210) days following the close of each fiscal year of such Municipal Customer, it will cause the books and accounts of its Municipal Customer Water System to be audited annually by independent certified public accountants, showing the receipts and disbursements on account of its Municipal Customer Water System, and each Municipal Customer shall promptly upon receipt provide a copy of such audit to Oak Lawn. Likewise, Oak Lawn will make and keep proper books and accounts (separate and apart from all other records and accounts of Oak Lawn) in which complete entries shall be made of all transactions relating to the Oak Lawn Regional Water System and, within two hundred ten (210) days following the close of the Fiscal Year, Oak Lawn will cause the books and accounts of the Oak Lawn Regional Water System to be audited annually by independent certified public accountants, showing the receipts and disbursements on account of the Oak Lawn Regional Water System, and Oak Lawn shall promptly upon receipt provide a copy of such audit to the Municipal Customers.

G. Maintain Ownership of Oak Lawn Regional Water System and Municipal Customer Water System and Properties. Oak Lawn with respect to the Oak Lawn Regional Water System and each Municipal Customer with respect to its Municipal Customer Water System will continue to own and possess such systems and will, within the exercise of reasonable business judgment and in a manner so as not to cause a default hereunder, dispose of property which is part of such systems only to the extent that such property is no longer useful or profitable in the operations of such systems.

H. Tax Status. (1) No Municipal Customer shall use or permit to be used any of the Chicago Water acquired under this Agreement or operate its Municipal Customer Water System in any manner or for any purpose or take any other action or omit to take any action which could, either alone or in conjunction with any other similar actions by that Municipal Customer or any

other Municipal Customers, result in loss of the exclusion from gross income for federal income tax purposes of the interest on any Bond or Bonds or entitlement of Oak Lawn to a credit payment from the United States Treasury (such as, for example, was available to units of local government for "build America bonds") in lieu of all or part of such exclusion from gross income (any of such advantages being "*Tax-Advantaged Status*"), or which could be issued in the future, as such Tax-Advantaged Status is governed by the federal income tax laws, as amended from time to time, including but not limited to, Section 141 of the Internal Revenue Code of 1986, as amended, and the Treasury Regulations or any rulings promulgated thereunder or as affected by a decision of any court of competent jurisdiction (collectively, the "*Tax Laws*").

(2) At the time of execution of this Agreement, each Municipal Customer represents for itself that it has no contracts (other than standard retail service agreements or arrangements by which water service is provided to all retail customers pursuant to rate schedules or ordinances, as amended from time to time, in the discretion of the respective corporate authorities) whereby any person, corporation, partnership or other entity other than Mokena and New Lenox agrees to purchase from such Municipal Customer any water provided to such Municipal Customer under this Agreement for a period of more than thirty (30) days, except as shown in *Exhibit "J"* hereto, and such Municipal Customer has no current expectation of entering into any such contracts, except as set forth in *Exhibit "J"* hereto. Other than as provided in the above text relating to the Tinley Park Branch System providing service to Mokena, New Lenox, and the Illinois American Water Company and service by Orland Park to said water company in the "Alpine Heights" area, which may be provided at any time, at least sixty (60) days prior to entering into any contract whereby any person, corporation, partnership or other entity agrees to purchase from any Municipal Customer any water provided to such Municipal Customer under this Agreement for a period of more than thirty (30) days, such Municipal Customer shall notify Oak Lawn of its intent to enter into such contract and provide copies of such contract to Oak Lawn. Within sixty (60) days after receipt of such notice, Oak Lawn shall advise such Municipal Customer as to whether, in the opinion of Bond Counsel selected by mutual agreement of the affected Municipal Customer and Oak Lawn, the entering into of such contract would result in a violation of the covenant in clause (1) above. The cost of this opinion shall be borne by such Municipal Customer. Any determination by Oak Lawn that any such contract would violate the covenant set forth in clause (1) above shall be made by Oak Lawn based upon the aforementioned opinion. In the event that allocations are necessary under the Tax Laws to determine whether entering into any such contract violates the covenant set forth in clause (1) above, Oak Lawn shall make such allocations, in its sole discretion, after receipt of an opinion of Bond Counsel as selected by Oak Lawn and paid for by such Municipal Customer.

I. Statement of Mutual Cooperation Process. The Statement of Mutual Cooperation Process (the "*Statement*") set forth in *Exhibit "P"* attached is hereby incorporated by reference; *provided, however*, that notwithstanding any text therein which may imply the contrary, (1) any advice or recommendation resultant from the actions taken under the Statement are advisory only, not in any way mandatory or directory upon Oak Lawn, (2) all information to be supplied by Oak Lawn under the Statement shall be supplied in good faith in a commercially reasonable manner but is not guaranteed as to accuracy, (3) default or noncompliance under the Statement shall not obviate or diminish in any way any of the other obligations, duties or rights of any Party under this Agreement, and (4) enforcement of obligations or rights under the Statement shall be

limited to actions for mandamus, declaratory relief, or the like, and no money damages may be awarded in connection with any such action. Nothing in this Section 18.I or *Exhibit "P"* shall diminish, limit or modify any other rights of the Municipal Customers under this Agreement or applicable law. All costs and expenses incurred as a result of the Working Groups (as defined in *Exhibit "P"*), except as specifically excluded in the immediately succeeding sentence, shall be treated as monthly Operation and Maintenance Costs of the Oak Lawn Regional Water System. The Southwest System Customers shall be solely responsible for any costs and expenses that the Southwest System Customers incur in conjunction with the Working Groups for independently retained experts and consultants, including but not limited to, auditors, accountants, architects, engineers and attorneys, and such costs and expenses shall not be included in the monthly Operation and Maintenance Costs of the Oak Lawn Regional Water System.

J. No Agency, Partnership or Joint Venture. Notwithstanding anything contained herein to the contrary, the Parties do not intend to create an agency, partnership, joint venture or employment relationship between the Parties and under no circumstances shall this Agreement be construed as one of agency, partnership, joint venture or employment between the Parties. The Parties shall each be solely responsible for the conduct of their respective officers, employees and agents in connection with the performance of their obligations under this Agreement.

Section 19. Service to Political Subdivisions. Any Municipal Customer entering into or renewing a wholesale contract or agreement with a person or entity constituting a governmental or like entity whose use of the services of the Oak Lawn Regional Water System would not adversely affect the ability of Oak Lawn to issue Bonds having Tax-Advantaged Status (*i.e.*, any such person or entity not described in the first sentence of Section 18.H(2) above), shall obtain such covenants in such contract or agreement enabling such Municipal Customer to meet its covenants under this Section 19 and Section 18.H. Oak Lawn acknowledges that the execution of this Agreement by Mokena and New Lenox fulfills Tinley Park's obligation under this Section with respect to the contracts or agreements Tinley Park has with Mokena and New Lenox.

Section 20. Billings and Computations; Security Deposit in Certain Events.

A. Delivery; Computation; Verify. All bills or statements of charges will be made in writing by Oak Lawn and mailed and delivered electronically to an officer of the Municipal Customers selected by the Municipal Customer or, in the absence of such designation, to the Municipal Manager or Administrator of the Municipal Customer. All computations required by this Agreement shall be made by Oak Lawn. At the request of a Municipal Customer and upon payment by the Municipal Customer of all fees and expenses related thereto, the Municipal Customers reserve the right to review, verify and/or audit such bills and changes with such consultants and/or accountants as retained by the Municipal Customers at their own cost and expense.

B. Notify Each Month. Oak Lawn shall notify each Municipal Customer (except for Mokena and New Lenox as set forth in Section 20.E) of such Municipal Customer's amount of all Aggregate Costs other than Capital Costs and Charges for a month on or before the 5th business day of the following month. The Municipal Customer's amount of Aggregate Costs other than Capital Costs and Charges for a month shall be due and payable and must be received by Oak Lawn

within fifteen (15) days after the date of notification. Oak Lawn shall notify each Municipal Customer of such Municipal Customer's amount of Capital Costs and Charges for each quarterly payment on or before the 5th business day of the month of the due date of such amount. The Municipal Customer's amount of Capital Costs and Charges for a quarter shall be due and payable and must be received by Oak Lawn on or before the last business day of the month.

C. Security Deposit in Certain Events. In the event (1) a Municipal Customer is rated below "BBB-" by S&P or "Baa3" by Moody's or (2) a Municipal Customer has defaulted on payments due under this Agreement, Oak Lawn may require such Municipal Customer to deposit money (the "*Security Deposit*") as security for payments due under this Agreement, upon written request. The Security Deposit shall be in an amount equal to the monthly average of the previous Fiscal Year's Aggregate Costs to that Municipal Customer and shall be paid immediately or accumulated in installments over time. The Security Deposit may be drawn upon at any time to make payments due and owing by the Municipal Customer under this Agreement or to avoid a default under this Agreement. If drawn upon, Oak Lawn may require the Municipal Customer to replenish said Security Deposit.

The Security Deposit shall be held in an account separate from all other accounts of Oak Lawn in trust for the purpose of making payments due under this Agreement. The Security Deposit may be invested in accordance with the investment policy of Oak Lawn. The investment income earned on the Security Deposit shall accrue to the benefit of the Municipal Customer in whose name such Security Deposit is established.

At its option, Oak Lawn may discontinue the requirement of the Security Deposit at any time and return the funds to the Municipal Customer in whose name the Security Deposit is held. However, Oak Lawn must return the Security Deposit to the Municipal Customer if (1) the Municipal Customer's rating has improved to "BBB-" (or higher) by S&P and "Baa3" (or higher) by Moody's and (2) the Municipal Customer has not been in default for a payment due under this Agreement for a period of three (3) years.

D. Access to Records; Disputes. In addition, Municipal Customers shall have access to Oak Lawn's water and financial department records at all reasonable business hours for the sole purpose of verifying the billing pursuant to this Section. If a Municipal Customer desires to dispute all or any part of any payments under this Agreement, the Municipal Customer shall nevertheless pay the full amount of any such payment when due and include with such payment written notification to Oak Lawn identifying the charges that are disputed, the grounds for the dispute and the amount in dispute within ninety (90) days after the time that the Municipal Customer knew or should have known of the facts giving rise to the dispute. Upon receipt of the notification of dispute, Oak Lawn representatives shall meet with the Municipal Customer's representatives to resolve such dispute. No adjustment or relief on account of any disputed charges shall be made unless such disputed charges are the subject of the notice. Oak Lawn and the Municipal Customer shall promptly attempt and continue efforts to resolve the dispute. In the event that it is determined that the Municipal Customer shall have overpaid, the Municipal Customer shall receive a refund. No actions by the Parties hereto and none of the provisions of this Agreement shall in any way whatsoever relieve any Municipal Customer's payment obligations. Each Municipal Customer will in each Fiscal Year make all budgetary, emergency or other provisions or appropriations

necessary to provide for and authorize the prompt payment by that Municipal Customer to Oak Lawn, during each Fiscal Year and on each payment date, of all the charges, payments and adjustments provided for in this Agreement.

E. Tinley Park Role in Billing Mokena and New Lenox. Oak Lawn shall notify Mokena and New Lenox directly with respect to their respective amounts of Capital Costs and Charges due according to Subsection B of this Section. Oak Lawn shall notify Tinley Park of all Aggregate Costs other than Capital Costs and Charges due from Mokena and New Lenox according to Section 20.B. Tinley Park shall remit the Aggregate Costs other than Capital Costs and Charges to Oak Lawn on behalf of Mokena and New Lenox, *provided, however*, that Tinley Park shall not be liable for such payments due from Mokena or New Lenox in the event that Mokena or New Lenox fails to pay. Tinley Park shall provide Oak Lawn with the details of each payment allocable to Mokena and New Lenox, including the amount of Chicago Water delivered to Mokena and New Lenox by Tinley Park.

Section 21. Future Water Customers; Special Connection Fees.

A. Permit Future Water Customers.

(1) Prior to entering into any written agreement for the purchase, sale, hypothecation or conveyance of Chicago Water pursuant to Sections 21.A(3) and 21.A(4), Oak Lawn shall first provide notice to the Municipal Customers: (a) that there is Available Capacity for the Chicago Water covered by such an agreement and (b) whether or not Oak Lawn proposes the Chicago Water to be sold, conveyed or hypothecated will be provided from the Oak Lawn Reserved Share and (c) the Proposed Component Cost Shares of any proposed Future Water Customer other than an Oak Lawn Reserved Share Customer as provided in the definition of Component Cost Share. In the event that Oak Lawn cannot provide Available Capacity as a result of a refusal by the Municipal Customers to approve repairs included in the approved Asset Management Plan for two years prior to the notice under this Section, then such lack of Available Capacity shall not preclude Oak Lawn from entering into a written agreement pursuant to Section 21.A(3).

(2) In the event the Southeast System Customers and Oak Lawn do not enter into a New Southeast Customer Agreement, Oak Lawn may at any time enter into agreements or contracts with the Southeast System Customers as Future Water Customers in the form of a Conforming Agreement. Until the Southeast Customers and Oak Lawn enter into a New Southeast Customer Agreement or a Conforming Agreement, Oak Lawn shall annually provide notice to each of the Southeast System Customers of that Customer's estimated payments for the Special Connection Fee and Old Bonds Special Connection Fee and shall also provide copies of said notices to the other Municipal Customers.

(3) At any time after one year after the Oak Lawn Regional Water System is Substantially Complete and Operational, Oak Lawn may sell, hypothecate or otherwise convey the Chicago Water which is part of the Oak Lawn Reserved Share pursuant to agreements or contracts with Oak Lawn Reserved Share Customers on such terms as Oak Lawn may in its sole discretion agree; *provided, however*, that Oak Lawn may not sell

any of the Oak Lawn Reserved Share to any of the Southeast System Customers before Oak Lawn and that Southeast System Customer have entered into a Conforming Agreement that is in full force and effect for the sale of Chicago Water to that Southeast System Customer for its Current Year Allocations. In the event of sales of the Oak Lawn Reserved Share, Oak Lawn shall pay a share of Electricity Costs, Transmission Main Maintenance Costs and Pump Station Maintenance Costs for such share in the same percentage as set forth in the Exhibits for such costs as the Municipal Customer most nearly located geographically to such Oak Lawn Reserved Share Customer. As to all other Aggregate Costs attributable to sale of the Chicago Water to an Oak Lawn Reserved Share Customer, except Capital Costs and Charges, Oak Lawn shall be deemed to have taken delivery of such Chicago Water.

(4) Except as otherwise provided in Sections 21.A(2) and 21.A(3), Oak Lawn may enter into agreements or contracts with other Future Water Customers only upon Corporate Consent Obtained of Municipal Customers other than Oak Lawn having not less than 80% of the 2030 Allocations of all the Municipal Customers other than Oak Lawn.

B. To Pay Special Connection Fee for Capital Costs and Charges. Unless Oak Lawn receives Corporate Consent Obtained of Municipal Customers other than Oak Lawn who are at the time Parties to this Agreement or the North Customer Agreements and who have not less than 80% of the 2030 Allocations of all such Municipal Customers, Oak Lawn agrees to charge Southeast System Customers who propose to become Future Water Customers not less than the amount of the Special Connection Fee. The Special Connection Fee shall be calculated as follows: the Buy In Base multiplied by a fraction, the numerator of which is the Projected Proportionate Share, and the denominator of which is the sum of the Proportionate Shares of the Municipal Customers who are obligated to pay Proportionate Shares and Future Water Customers who have participated in the payment of Capital Costs and Charges for the full Fiscal Year preceding the Connection Fee Date (collectively, "*Participating Customers*"). This formula is further expressed as follows:

Projected Proportionate Share	X	Buy In Base	=	Special Connection Fee
<hr/> Proportionate Shares of the Participating Customers for a period preceding the Connection Fee Date during which all Customers paid Capital Costs and Charges				

An example of the Special Connection Fee computation is shown in *Exhibit "M"*, which example shall be non-binding and for illustrative purposes only.

Such Special Connection Fee shall be paid to all Participating Customers on a proportionate basis based upon the following formula:

Special Connection Fee	X	Participating Customer's Proportionate Share for a period preceding the Connection Fee Date during which all such Customers paid Capital Costs and Charges <hr/> The total Proportionate Shares of all Participating Customers for a period preceding the Connection Fee Date during which all such Customers paid Capital Costs and Charges	=	Participating Customer's share of the Special Connection Fee
------------------------	---	---	---	--

C. *To Pay Proportionate Shares.* Oak Lawn shall require each Southeast System Customer which becomes a Future Water Customer to pay its Proportionate Share (as calculated below) of Capital Costs and Charges on a take or pay basis as is provided herein, having the effect of reducing the Proportionate Shares of Participating Customers at the time, and, accordingly, the Proportionate Shares of Participating Customers will be adjusted at said time as stated in Exhibit "E" or as otherwise provided in this Agreement. The Proportionate Share allocable to a Southeast System Customer which becomes a Future Water Customer shall be *not less than* the share determined pursuant to the Cost Methodology.

D. *To Pay Old Bonds Special Connection Fee.* Unless Oak Lawn receives Corporate Consent Obtained of all Municipal Customers other than Oak Lawn who have made payments of principal and interest on the Old Bonds, Oak Lawn agrees to charge any of the Southeast System Customers who propose to become Future Water Customers, or any Future Water Customers other than an Oak Lawn Reserved Share Customer, who propose to utilize any portion of the improvements paid for by any portion of the Old Bonds not less than the amount of the Old Bonds Special Connection Fee or Oak Lawn may elect to pay said Old Bonds Special Connection Fee itself.

Section 22. *Special Connection Fee Payments to Oak Lawn Retail Water System and Certain Municipal Customers.* Subject to the terms of any proceeding, ordinance or resolution or related document such as an indenture of Oak Lawn relating to issuance of Bonds as to payments being made subordinate to other prior claims on Regional System Revenues (such as being payable from surplus or a surplus account or from generally available revenues after prior account requirements shall have been met), each of the Oak Lawn Retail Water System and certain of the Municipal Customers shall be entitled to receive the payments from the Oak Lawn Regional Water System of the Special Connection Fee in the relative amounts provided for same in Section 21.

Section 23. *Indemnity/Insurance.*

A. *Municipal Customer Indemnity.* Each Municipal Customer, to the fullest extent permitted by law, agrees to save, keep and hold Oak Lawn harmless from any and all damages of every kind, nature and description, including attorney's fees, which Oak Lawn may suffer as a result of that Municipal Customer's operation or use of that Municipal Customer Water System provided for herein and for any of that Municipal Customer's breaches of this Agreement.

B. Oak Lawn Indemnity. Oak Lawn, to the fullest extent permitted by law, agrees to save, keep and hold Municipal Customers harmless from any and all damages of every kind, nature and description, including attorney's fees, which Municipal Customer may suffer as a result of Oak Lawn's operation or use of the Oak Lawn Regional Water System provided for herein and for any of Oak Lawn's breaches of this Agreement.

C. Insurance. Each Municipal Customer with respect to its Water System and Oak Lawn with respect to the Oak Lawn Regional Water System shall insure or self-insure such systems against physical damages or losses, tort claims, unemployment insurance claims, and other losses commonly covered by insurance in such manner as is commonly provided in the industry for similar water system operations. All such insurance or self-insurance programs shall be in accordance with recommendations made not less often than every five (5) years by an independent insurance consultant who, in the case of self-insurance, shall provide recommended levels of reserves. Upon request, the Parties agree to supply each other copies of the current insurance recommendations and the status of insurance procured and reserves maintained in response thereto. Any insurance provided pursuant to this Agreement shall not limit the indemnity obligations of the Parties under this Agreement.

D. Notice of Claims. In the event of a potential claim under the indemnity obligations of this Agreement or under the insurance required by this Agreement, the Party making such a claim shall promptly notify the Party against which such a claim is directed of the nature of the claim, the extent of the claim, and such other information as to reasonably inform the other Party of the claim.

Section 24. Compliance with All Applicable Rules and Regulations. No Municipal Customer shall contaminate Chicago Water supplied by the Oak Lawn Regional Water System during delivery of such water through the Municipal Customer Water System. Oak Lawn reserves the right, based upon reasonable cause and following reasonable notice, given the circumstances, to make inspections of and perform tests with respect to those facilities within a Municipal Customer Water System which may affect the quality of Chicago Water supplied to the Municipal Customer through the Oak Lawn Regional Water System.

Section 25. Consequential Damages. In no event shall Oak Lawn be liable to any Municipal Customer for any special or consequential damages, including, but not limited to, loss of income, loss of revenue, loss of profits, loss of use, loss of capital, rental expenses, financing, reputation, overhead expenses, or interest, whether based on contract, tort, negligence, strict liability, or otherwise and arising from any cause whatsoever by performance under this Agreement or breach of this Agreement.

Section 26. Approvals and Consents; Corporate Consent Obtained; Executive Consent Obtained.

A. In General. Except as otherwise expressly provided or modified in this Agreement, any action subject to approval or consent or denial by the Municipal Customers shall be either by Corporate Consent Obtained or Executive Consent Obtained. Except as otherwise expressly provided or modified in this Agreement, consent means the approval or consent of the Municipal Customers having 51% or more of the 2030 Allocations of all Municipal Customers who are

Parties to this Agreement, Parties to the North Customer Agreements, Parties to the New Southeast Customer Agreements and Future Water Customers that have entered into Conforming Agreements that are in full force and effect.

B. Corporate Consent Obtained. Corporate Consent Obtained is consent by the corporate authorities of the Municipal Customers. Such consent or denial of consent may be provided, and shall be conclusively evidenced by, a copy, certified by a Party's acting or deputy or assistant Municipal Clerk and under such municipality's seal, of such proceedings, ordinances, resolutions or other records purporting to provide such consent or denial of consent. Consent or denial of consent must be received within sixty-five (65) days after the receipt of notice giving rise to the power of consent or denial of consent. If no consent or denial of consent is received from a given Municipal Customer within the time provided in the foregoing sentence (or other express provision relating to time of consent or denial), then such Municipal Customer shall be conclusively deemed to have provided the required written consent.

C. Executive Consent Obtained. Executive Consent Obtained is consent by the Municipal Manager or by the designee(s) of such Municipal Manager; *provided however*, if and only if the Municipal Manager and the designee(s) of the Municipal Manager are unavailable, the Mayor or President of the Municipal Customer may provide consent (the person so acting on any matter for a Municipal Customer being referred to herein as its "*Authorized Representative*"). Each Municipal Customer shall provide Oak Lawn up-to-date name and contact information, including official, mobile, and home telephone numbers and official email addresses for each Municipal Manager and Mayor or President. Unless otherwise provided, the notice provisions as set forth in Section 34 herein shall apply.

Unless otherwise provided, consent or denial of consent must be received within thirty (30) days after the receipt of notice giving rise to the power of consent or denial of consent. If no consent or denial of consent is received from a given Authorized Representative within the time provided herein (or other express provision relating to time of consent or denial), then such Municipal Customer shall be conclusively deemed to have provided the required written consent.

Section 27. Force Majeure. In case by reason of *force majeure* any Party to this Agreement shall be rendered unable wholly or in part to carry out any obligation under this Agreement, then if such Party shall give notice and full particulars of such *force majeure* in writing to the other Parties within a reasonable time after occurrence of the event or cause relied on, the obligation of the Party giving such notice, so far as it is affected by such *force majeure*, shall be suspended during the continuance of the inability then claimed, but for no longer period, and any such Party shall endeavor to remove or overcome such inability with all reasonable dispatch. The settlement of strikes and lockouts (as described in the definition of *force majeure*) shall be entirely within the discretion of the Party having the difficulty and that the above requirement that any *force majeure* shall be remedied with all reasonable dispatch shall not require the settlement of strikes and lockouts by acceding to the demands of the opposing Party or Parties when such settlement is unfavorable to it in the judgment of the Party having the difficulty. No *force majeure* which renders any of the Parties unable to perform under this Agreement shall relieve a Party of its obligation to make the payments which constitute take or pay agreed-upon payments as set forth above in the payment terms in Sections 2 and 15.

Section 28. Enforcement.

A. *Oak Lawn to Enforce.* Oak Lawn will at all times take all reasonable measures permitted by law to collect and enforce payment of all payments, charges and adjustments provided for in this Agreement.

B. *May Pursue Any Remedies.* Every obligation assumed by or imposed upon Municipal Customers by this Agreement shall be enforceable by Oak Lawn by appropriate action or proceeding, and Oak Lawn may have and pursue any and all remedies provided by law for the enforcement of such obligation.

C. *Failure by Oak Lawn.* Failure on the part of Oak Lawn in any instance or under any circumstance to observe or fully perform any obligation assumed by or imposed upon it by this Agreement except its willful failure to supply Chicago Water hereunder without just cause, shall not relieve any Municipal Customer from making any payment to Oak Lawn or fully performing any other obligation required of it under this Agreement. Municipal Customers have and may pursue any and all other remedies provided by law for compelling performance by Oak Lawn of said obligation assumed by or imposed upon Oak Lawn.

D. *Pursuit of Legal Remedies.* In the event any payment due hereunder is not paid by Municipal Customer, Oak Lawn may pursue any and all legal options available to it under this Agreement and the laws of the State of Illinois.

Section 29. Default.

A. *Oak Lawn May Immediately Terminate.* Oak Lawn may, by written notice to a given Municipal Customer, immediately terminate this Agreement solely with respect to such Municipal Customer if:

- (1) That Municipal Customer admits in writing an inability to pay its obligations under this Agreement as they become due;
- (2) That Municipal Customer persistently fails to perform any of its payment obligations under this Agreement;
- (3) That Municipal Customer abandons operation of its Municipal Customer Water System; or
- (4) The Chicago-Oak Lawn Agreement is terminated.

B. *Oak Lawn May Terminate After Notice and Opportunity to Cure.* Subject to and upon completion of the dispute resolution provisions contained in Section 30, for all other defaults that do not allow for immediate termination pursuant to Section 29.A, if a Municipal Customer shall fail, after thirty (30) days written notice of the Municipal Customer's default of any term of this Agreement, to cure, or undertake reasonable efforts to cure the default within ninety (90) days of the written notice if such cure cannot reasonably be completed within thirty (30) days, Oak Lawn

may terminate this Agreement solely with respect to such Municipal Customer by providing written notice of termination to the Municipal Customer with a copy to the other Southwest System Customers. Such termination shall be effective upon Oak Lawn's sending of the written notice of termination.

C. Certain Effects of Termination. In the event of any termination, the Proportionate Shares as shown in *Exhibit "E"* shall be recomputed among the remaining Municipal Customers using the Cost Methodology; and the Allocation of Electricity Costs as shown in *Exhibit "F"*, Allocation of Pump Station Maintenance Costs as shown in *Exhibit "G"*, and Allocation of Transmission Main Maintenance Costs as shown in *Exhibit "H"* shall be recomputed among the remaining Municipal Customers based on the methods for each such cost in the respective exhibits. In the event that Oak Lawn shall terminate with respect to Tinley Park, all rights of Mokena and New Lenox hereunder shall remain unaffected.

D. Municipal Customers May Not Terminate. Except as otherwise provided in Section 41 of this Agreement, Municipal Customers shall have no right to terminate, cancel or rescind this Agreement, nor any right to withhold from Oak Lawn payments due or to become due under this Agreement, nor any right to recover from Oak Lawn amounts previously paid under this Agreement (unless paid in error or contrary to the provisions of this Agreement or law), nor any right of reduction or set-off against the amounts due or to become due under this Agreement to Oak Lawn, nor any lien on any amounts in any fund established by Oak Lawn for any reason or on account of the existence or occurrence of any event, condition or contingency, whether foreseen or unforeseen or foreseeable or unforeseeable by the Municipal Customers or Oak Lawn or any other person; including by way of illustration and not limitation, by reason of the fact that the Oak Lawn Regional Water System in whole or in part is not completed, operable or operating; the output of the Oak Lawn Regional Water System in whole or in part is suspended, interrupted, interfered with, reduced or curtailed; either party to the Chicago-Oak Lawn Agreement, including Chicago, does not perform in whole or in part thereunder; any of the Municipal Customers' allocations of Chicago Water received from the IDNR is modified or terminated or any Municipal Customer or Future Water Customer does not perform in whole or in part under any agreement with Oak Lawn; it being the intent hereof that each Municipal Customer shall be absolutely and unconditionally obligated to make all payments under this Agreement, such obligations to survive termination of this Agreement. Oak Lawn will issue its Bonds in specific reliance upon the limitations set forth in this Section with respect to the rights of the Municipal Customers.

Section 30. Dispute Resolution.

A. Negotiation. The Parties desire to avoid and settle without litigation any future disputes that may arise between them relative to this Agreement. Accordingly, the Parties agree to engage in good faith negotiations to resolve any such dispute. If any Party has a dispute about a violation, interpretation, or application of a provision of this Agreement, or a dispute regarding a Party's failure to comply with this Agreement, then that Party may serve on the other Party written notice, delivered as provided in Section 34, setting forth in detail the dispute, the provisions of this Agreement to which the dispute is related, and all facts and circumstances pertinent to the dispute. The Parties then, within seven (7) days, shall schedule a date certain for representatives of the

Parties to meet in a conference to resolve the dispute. Such conference shall be conducted within thirty (30) days after notice of the dispute has been delivered as provided herein.

B. Continuation of Services and Payments. During all negotiation proceedings and any subsequent proceedings provided for in this Section, Oak Lawn and the Municipal Customers shall continue to fulfill the terms of this Agreement to the fullest extent possible. Oak Lawn shall continue to provide Chicago Water to the Municipal Customers as provided by this Agreement. The Municipal Customers shall continue to make all payments to Oak Lawn for Chicago Water as provided by this Agreement, including all payments about which the Municipal Customers have or may have a dispute.

C. Remedies. Provided that the Parties have met their obligations under Section 30.A, the Parties shall be entitled to pursue such remedies as may be available in law and equity. The requirements of Subsection A of this Section 30 shall be waived in the event of either significant risk of irreparable harm or significant jeopardy to public health and safety.

Section 31. Substitution of More Favorable Provisions.

A. Copy Provided. Oak Lawn must provide, within seven (7) days after a request from the Southwest System Customers, a copy of any water sale, purchase or service agreement between Oak Lawn and any other Municipal Customer or Future Water Customer.

B. Customer Determination. If the Southwest System Customers learn of an Other Agreement that has a Favorable Provision, then the Southwest System Customers may each adopt an ordinance adding to this Agreement any such Favorable Provision from the Other Agreement and deleting from this Agreement the provisions, if any, for which any Favorable Provision has been substituted. Each Favorable Provision adopted by the Southwest System Customers must be substantially identical to the provision in the Other Agreement, and Oak Lawn must accept the Favorable Provision as a term of this Agreement, subject to the procedures set forth below.

C. Notice to Oak Lawn. Any Southwest System Customer adopting such an ordinance pursuant to this Section shall provide written notice to Oak Lawn of such action within thirty (30) days after such ordinance becomes effective. Such notice shall be delivered as provided in Section 34 and shall include a copy of the ordinance.

D. Disputes. If Oak Lawn disagrees with the action(s) taken pursuant to an ordinance adopted by a Southwest System Customer pursuant to this Section, such disagreement shall be initially subject to the process set forth in Section 30.

E. Mediation. If the Parties are unable to resolve their disagreement under this Section 31 through the dispute resolution process in Section 30, the Parties agree to attempt to resolve any such disagreement under this Section 31 by mediation, which shall be conducted pursuant to any applicable Illinois law and the then current procedures of, and using a mediator from, ADR Systems or, if ADR Systems is unable to handle the mediation, the Association of

Attorney-Mediators (Illinois Chapter), or any other procedure and mediator upon which the Parties may agree.

(1) The Parties further agree that their respective good faith participation in mediation is a condition precedent to pursuing any other available legal or equitable remedy, including litigation.

(2) Either Oak Lawn or the Southwest System Customers may commence the mediation process by providing to the other Parties written notice, setting forth the bases for the disagreement and the result requested. Within ten (10) days after the receipt of the foregoing notice, the other Parties shall deliver a written response to the initiating Party's notice. The initial mediation session shall be held within thirty (30) days after the initial notice. The Parties agree to share the costs and expenses of the mediation with one-half paid by Oak Lawn and one-half paid by the Southwest System Customers (which shall not include the expenses incurred by each Party for its own legal representation in connection with the mediation).

(3) The Parties further acknowledge and agree that mediation proceedings are settlement negotiations and that, to the extent allowed by applicable law, all offers, promises, conduct and statements, whether oral or written, made in the course of the mediation by any of the Parties or their agents shall be confidential and inadmissible in any other legal proceeding involving the Parties; *provided, however*, that evidence which is otherwise admissible or discoverable shall not be rendered inadmissible or non-discoverable as a result of its use in the mediation.

(4) At no time prior to the initial meeting shall any Party initiate any litigation relating to the disagreement under this Section 31. However, this limitation is inapplicable to a Party if another Party refuses to comply with the requirements of paragraphs (1) and (2) above.

(5) All applicable statutes of limitation and defenses based on the passage of time shall be tolled while the procedures specified in paragraphs (1) and (2) above are pending and for fifteen (15) days thereafter. The Parties will take such action, if any, required to effectuate such tolling.

F. *Further Remedies.* If the Parties are unable to resolve their disagreement pursuant to mediation as set forth above, then any Party may pursue any remedy at law or in equity as may be available to it.

Section 32. Records. Except as otherwise prohibited by law, or as otherwise excluded by other sections of this Agreement, the Southwest System Customers shall have reasonable access to records pertaining to the Oak Lawn Regional Water System and to those records pertaining to Oak Lawn's compliance with its obligations under this Agreement, and for the purposes of inspection by any authorized representatives of the Southwest System Customers, including the Working Groups, during regular business hours, upon reasonable notice, to the same extent as such records are available for inspection by any authorized representatives of Oak Lawn.

Section 33. Successors and Assigns. This Agreement may not be assigned by any Party without the prior written consent of the other Parties; *provided, however*, because this Agreement is made with particular reference to the holders or prospective holders of the Bonds for the purpose of assuring and protecting the interests of such holders, Oak Lawn may at any time assign or pledge for the benefit and security of the holders of the Bonds all of its rights under the provisions of this Agreement to receive payments from Municipal Customers. This Agreement shall be binding upon the Parties, and their respective successors, assigns, heirs and legal representatives, subject, however, to the provisions hereof limiting assignment.

Section 34. Notices. All notices or communications provided for herein shall be in writing and shall be delivered to Municipal Customer or Oak Lawn either (i) in person or, (ii) by a reputable overnight courier, (iii) by United States mail “via, certified mail, return receipt requested”, postage prepaid, addressed:

to Municipal Customers as follows:

Mokena

Village Administrator
Village of Mokena
11004 Carpenter Street
Mokena, Illinois 60448

New Lenox

Village Administrator
Village of New Lenox
1 Veterans Parkway
New Lenox, Illinois 60451

Oak Forest

City Administrator
City of Oak Forest
15440 South Central Avenue
Oak Forest, Illinois 60452

Orland Park

Village Manager
Village of Orland Park
14700 South Ravinia Avenue
Orland Park, Illinois 60462

Tinley Park

Village Manager
Village of Tinley Park
16250 South Oak Park Avenue
Tinley Park, Illinois 60477

to Oak Lawn as follows:

Village Manager
Village of Oak Lawn
9446 South Raymond Drive
Oak Lawn, Illinois 60453

Unless otherwise provided in this Agreement, notices shall be deemed received after the first to occur of (a) the date of actual receipt; or (b) the date that is one (1) business day after deposit with

an overnight courier as evidenced by a receipt of deposit; or (c) the date that is three (3) business days after deposit in the U.S. mail, as evidenced by a return receipt. By notice complying with the requirements of this Section 34, each Party to this Agreement shall have the right to change the address or the addressee, or both, for all future notices and communications to them, but no notice of a change of addressee or address shall be effective until actually received.

Section 35. Section and other Headings. Section or other headings contained in this Agreement are for reference purposes only and shall not affect in any way the meaning or interpretation of this Agreement.

Section 36. Construction. This Agreement is the end result of the combined effort of the Parties and has been jointly negotiated, drafted and reviewed by each Party and its respective attorneys. No one Party shall be deemed to have drafted this Agreement and no ambiguity in this Agreement shall be interpreted or construed against any Party.

Section 37. Superseder; Amendment; Waiver.

A. Exhibits. All Exhibits attached hereto are incorporated into and made a part of this Agreement.

B. Entire Agreement. This Agreement and the Exhibits attached hereto constitute the entire Agreement between Oak Lawn and the Southwest System Customers for the purchase and sale of Chicago Water, and the intergovernmental agreements between or among some or all of the Parties to this Agreement including but not limited to those that are listed in *Exhibit "N"* to this Agreement are hereby superseded and shall be of no further force and effect. Contracts or Agreements to which Oak Lawn is not a party are neither superseded nor affected by this Agreement.

C. Amendments and Waivers. No addition, deletion, revision, alteration, change, modification or waiver of any term or condition of this Agreement shall be binding on any Party unless made in writing and signed by the Parties. The failure by a Party to enforce any provision of this Agreement or to require performance by the other Parties will not be construed to be a waiver, or in any way affect the right of any Party to enforce such provision thereafter.

D. Limitations on Modifications. No such change or modification may materially impair or adversely affect the ability or obligation of any Municipal Customer to make payments to Oak Lawn at the times, in the amounts, and with the priority required in order for Oak Lawn to timely meet Oak Lawn's obligations under this Agreement, the Chicago-Oak Lawn Agreement, other Oak Lawn water purchase or sale contracts and the Bonds, including without limitation the making of all deposits in various funds and accounts created under the proceedings, resolution or any ordinance authorizing the Bonds or any related document such as an indenture; or materially impair or adversely affect the ability of the holders of the Bonds, to enforce the terms of this Agreement. No such change or modification which will affect the rights and interest of the holders of the Bonds shall be made without the written approval of an authorized representative of the holders of at least seventy percent (70%) of the outstanding Bonds and no such change or

modification shall be effective which would cause a violation of any provisions of the resolution or any ordinance authorizing the Bonds of Oak Lawn.

Section 38. Severability. Should any part, term or provision of this Agreement be determined by a court of competent jurisdiction to be illegal or in conflict with any law, the validity of the remaining portions or provisions shall not be affected thereby.

Section 39. Choice of Law. This Agreement shall be governed by and construed in accordance with the laws of the State of Illinois, without giving effect to its principles of conflict of laws.

Section 40. Execution in Counterparts. This Agreement may be executed in any number of counterparts, each of which shall be executed by Oak Lawn and the other Parties and all of which shall be regarded for all purposes as one original and shall constitute and be but one and the same.

Section 41. Effective Date and Term of Agreement.

A. Effective Date. This Agreement shall be in full force and effect and shall become binding upon the Parties if, on or before December 31, 2014, (1) each of North System Customers submits to Oak Lawn an original signed copy of the North Customer Agreements, as an offer, and Oak Lawn countersigns such North Customer Agreements as acceptance, and (2) each of Mokena, New Lenox, Oak Forest, Orland Park, and Tinley Park submits to Oak Lawn an original signed copy of this Agreement, as an offer, and Oak Lawn countersigns such Agreement as acceptance. Provided all such conditions have been met, the Effective Date of this Agreement shall be the first day of the month next following the completion of the actions set forth in clauses (1) and (2) above. The Parties hereto further agree to provide a sufficient number of duplicate originals of this Agreement so as to provide one such duplicate original to each Party. Oak Lawn agrees to supply certified copies of the North Customer Agreements to the Parties hereto promptly after execution.

B. Term. From and after the Effective Date, this Agreement shall remain in full force and effect for forty (40) years, up to and including a date in the year 2054.

C. Termination and Renewal. This Agreement may be terminated pursuant to one of the following procedures: (1) by written amendment to this Agreement duly authorized by the appropriate legislative action of all of the Parties; (2) written notice pursuant to Subsection D of this Section; or (3) by written notice served by the Party desiring to terminate this Agreement at the end of the Term stated above, specifically stating that the Party sending the notice intends that the Agreement will terminate without renewal, such notice to be effective only if served upon the other Party not more than thirty-six (36) months and not less than thirty (30) months prior to the expiration of the Term. In the event that either Oak Lawn or one or more of the Southwest System Customers provides written notice pursuant to the notice provision of clause (2) of this Section 41.C, each Party to this Agreement agrees to appoint, delegate and authorize its Chief Administrative Officer to meet and confer with the appointed, delegated and authorized Chief Administrative Officers of the other Parties promptly thereafter to discuss the reasons for the termination notice and whether there are circumstances under which the Parties might mutually

agree to renewal and continue their cooperative relationship under this Agreement. If a Party does not have a Chief Administrative Office in place, then the Mayor or Village President shall participate in this meeting process. The Parties agree to use their best efforts and to work in good faith through this meeting process to resolve all issues precipitating the notice of termination. These efforts shall continue for a period of not less than twelve (12) months following the notice.

D. Partial Termination Due to Failure of Oak Lawn to Construct 2013 Regional System Improvements. Notwithstanding the provisions of Section 29, the Southwest System Customers may terminate this Agreement upon the occurrence of the following: (1) Oak Lawn has failed to issue any of the New Series Bonds for a period of three years after the Effective Date of this Agreement; or (2) Oak Lawn has not awarded at least three (3) of eight (8) Bid Packages within three (3) years after the Effective Date of this Agreement. If the Southwest System Customers find that the above prerequisites exist, the Southwest System Customers may give Oak Lawn notice within three years and three months after the Effective Date of this Agreement that this Agreement will terminate on a designated date not more than three years after the date of such notice. This Agreement will terminate as of the date designated in such notice, unless otherwise mutually agreed by the Parties. Upon termination, those obligations to pay Capital Costs and Charges incurred prior to termination and any covenants related to the payments of Bonds and coverage requirements related thereto shall continue until said obligations have been paid.

[REMAINDER OF PAGE INTENTIONALLY LEFT BLANK]

IN WITNESS WHEREOF, Oak Lawn and Southwest System Customers have caused their respective corporate seals to be hereunto affixed and attested and these presents to be signed by their respective officers

SOUTHWEST SYSTEM CUSTOMERS:

VILLAGE OF MOKENA

By: 
Its: Village President

ATTESTED:

Municipal Clerk

[SEAL]

DATED: October 28, 2020

VILLAGE OF NEW LENOX

By: _____
Its: Mayor

ATTESTED:

Municipal Clerk

[SEAL]

DATED: _____, 2020

IN WITNESS WHEREOF, Oak Lawn and Southwest System Customers have caused their respective corporate seals to be hereunto affixed and attested and these presents to be signed by their respective officers

SOUTHWEST SYSTEM CUSTOMERS:

VILLAGE OF MOKENA

By: _____
Its: Village President

ATTESTED:

Municipal Clerk

[SEAL]

DATED: _____, 2020

VILLAGE OF NEW LENOX

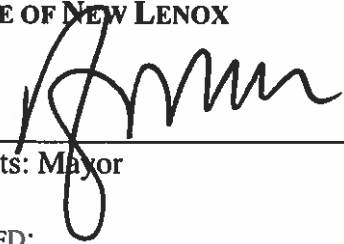
By:  _____
Its: Mayor

ATTESTED:



Municipal Clerk

[SEAL]

DATED: Oct 12, 2020

CITY OF OAK FOREST

By: *N. J. Kuspa*
Its: Mayor

ATTESTED:

 J. J. J. J.
Municipal Clerk

[SEAL]

DATED: *Oct. 27* , 2020



VILLAGE OF ORLAND PARK

By: _____
Its: Village President

ATTESTED:

Municipal Clerk

[SEAL]

DATED: _____, 2020

CITY OF OAK FOREST

By: _____
Its: Mayor

ATTESTED:

Municipal Clerk

[SEAL]

DATED: _____, 2020

VILLAGE OF ORLAND PARK

By: 
Its: Village President

ATTESTED:

Municipal Clerk

[SEAL]

DATED: October 23, 2020

VILLAGE OF TINLEY PARK

By: 
Its: Village President

ATTESTED:

Municipal Clerk

[SEAL]

DATED: October 20, 2020

OAK LAWN:

VILLAGE OF OAK LAWN

By: _____
Its: Village President

ATTESTED:

Municipal Clerk

[SEAL]

DATED: _____, 2020

VILLAGE OF TINLEY PARK

By: _____
Its: Village President

ATTESTED:

Municipal Clerk

[SEAL]

DATED: _____, 2020

OAK LAWN:

VILLAGE OF OAK LAWN

By: _____
Its: Village President

ATTESTED:

Jane M. Zundar, mnc

Municipal Clerk

[SEAL]

DATED: September 22, 2020



Exhibit A

Description of Oak Lawn Retail Water System

The Oak Lawn Retail Water System serves to store and distribute potable water (i.e., Chicago Water), purchased from the City of Chicago and obtained through the Oak Lawn Regional Water System, to Chicago Water customers within the Village of Oak Lawn. The Oak Lawn Retail Water System is generally comprised of the following major components:

1. Thousands of feet of 24-inch (and smaller) transmission and distribution main.
2. Two, one-million gallon, elevated storage tanks.
3. One, sectionalized, 8-million gallon, ground storage reservoir located at the Reich Storage and Pumping Complex (i.e., the Reich Complex).
4. One, sectionalized, 8-million gallon, ground storage reservoir located at the Harker Storage and Pumping Complex (i.e., the Harker Complex).

Upon completion of the 2013 Regional System Improvements, the Oak Lawn Retail Water System and the Village of Chicago Ridge will share 28,500 feet of combined distribution/transmission main between the Reich and Harker Complexes and the Point of Delivery for the Village of Chicago Ridge. The capacity of the aforementioned shared distribution/transmission main that is needed to supply Chicago Water to the Village of Chicago Ridge has been estimated by independent engineers to represent seventeen percent (17%) of the total capacity of the shared infrastructure. Chicago Ridge will pay an additional charge to Oak Lawn for use of this seventeen percent (17%) share of the Oak Lawn Retail Water System.

Exhibit B
Oak Lawn Regional Water System Points of Delivery to Municipal Customers

(The Southeast System Customers have no knowledge of, and make no representation or agreements regarding, the Points of Delivery for the other Municipal Customers depicted in this Exhibit B.)

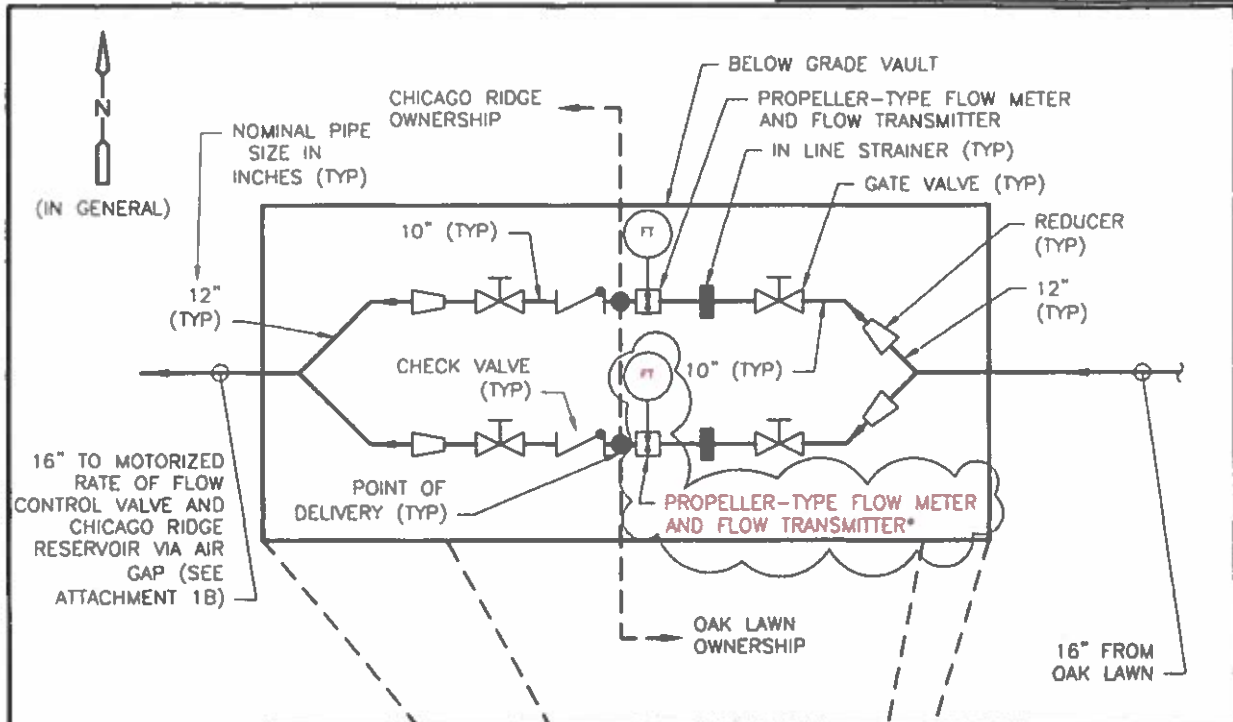

LEGEND

MOTORIZED DEVICE

(TYP) TYPICAL

* TO BE INSTALLED BY OAK LAWN AS PART OF THE 2013 REGIONAL SYSTEM IMPROVEMENTS

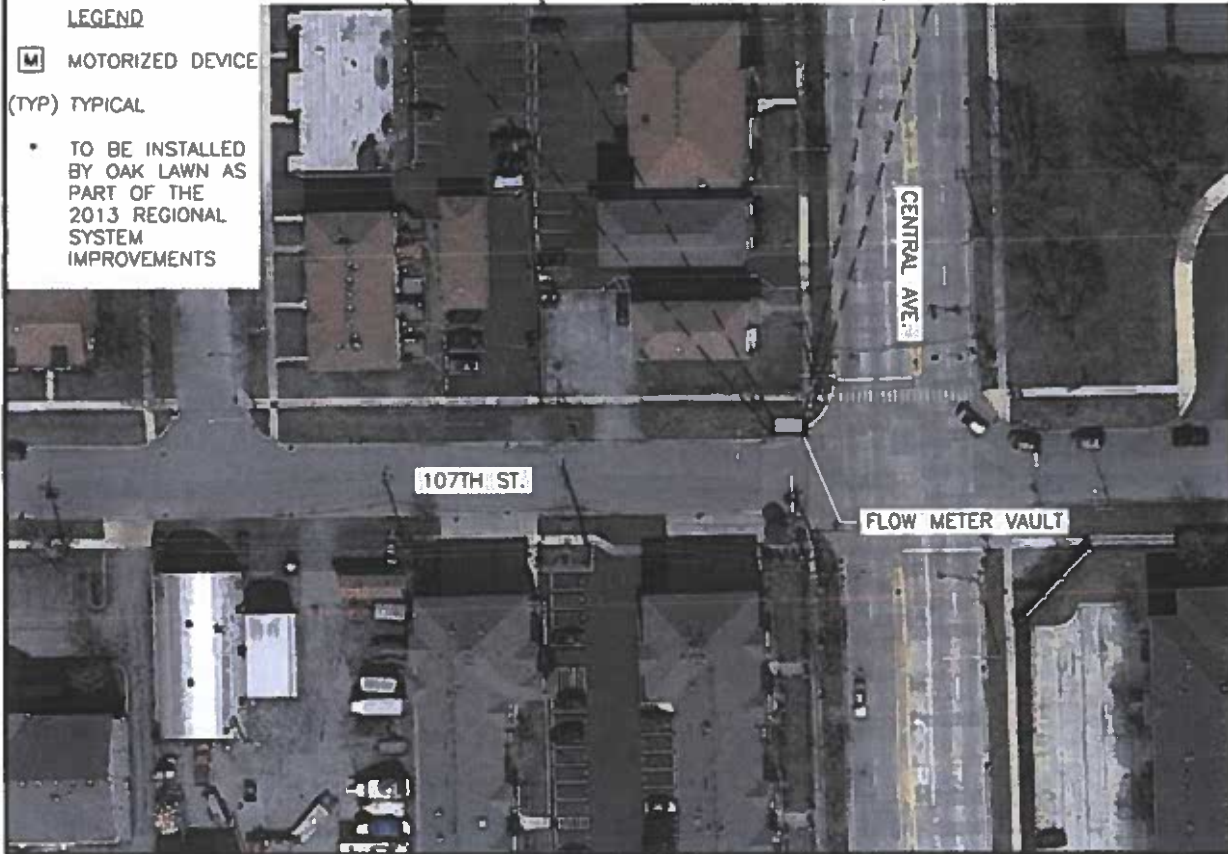

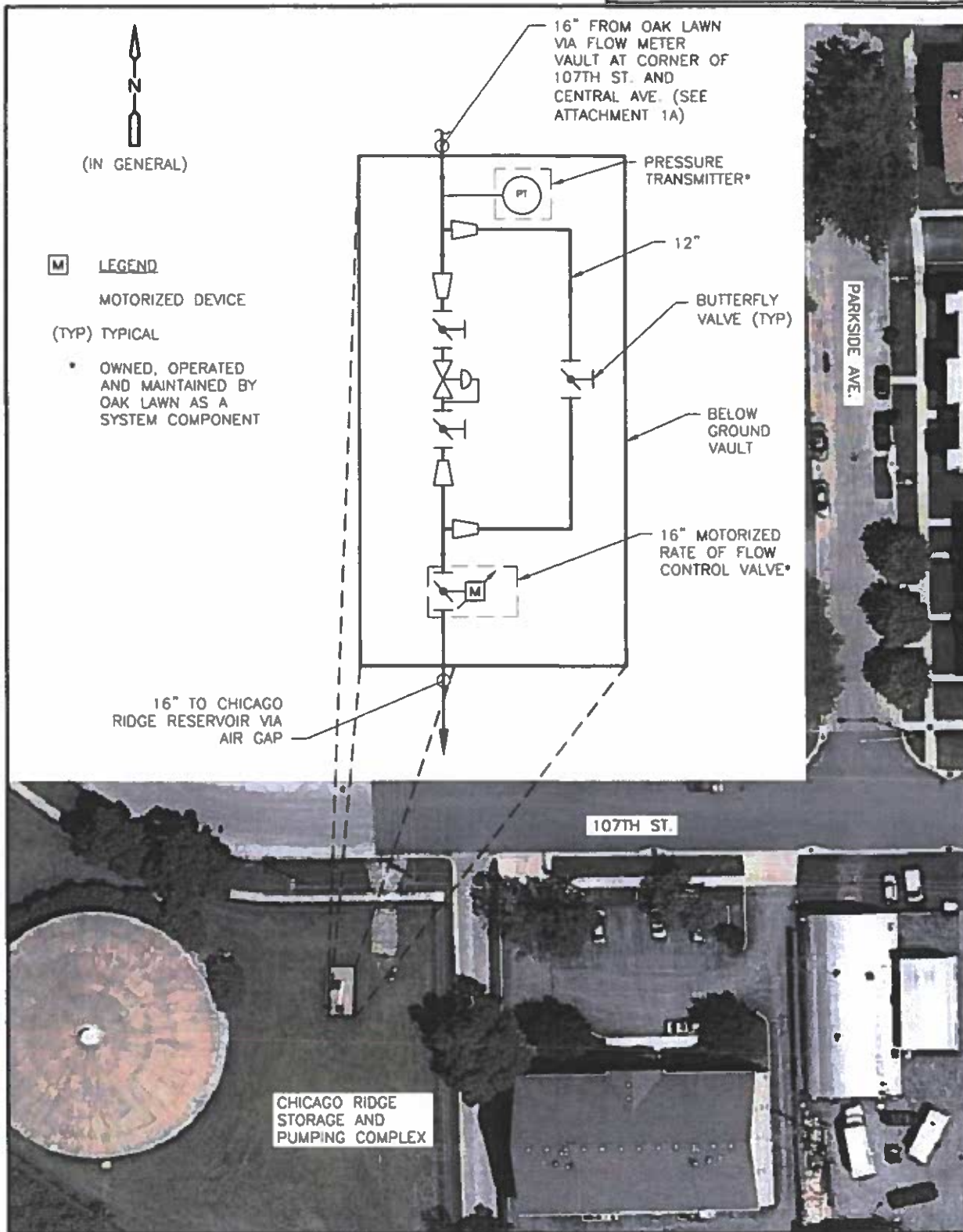

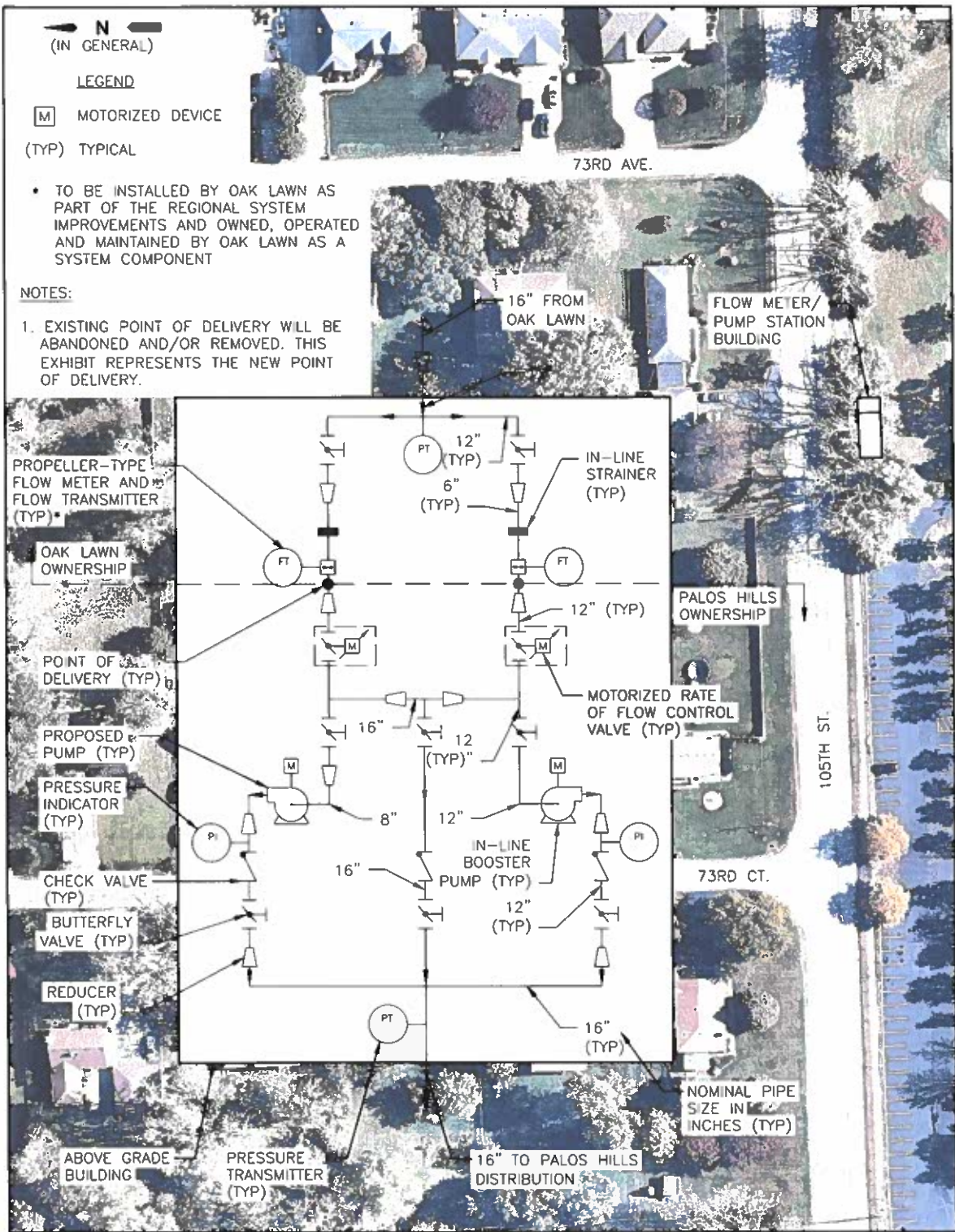

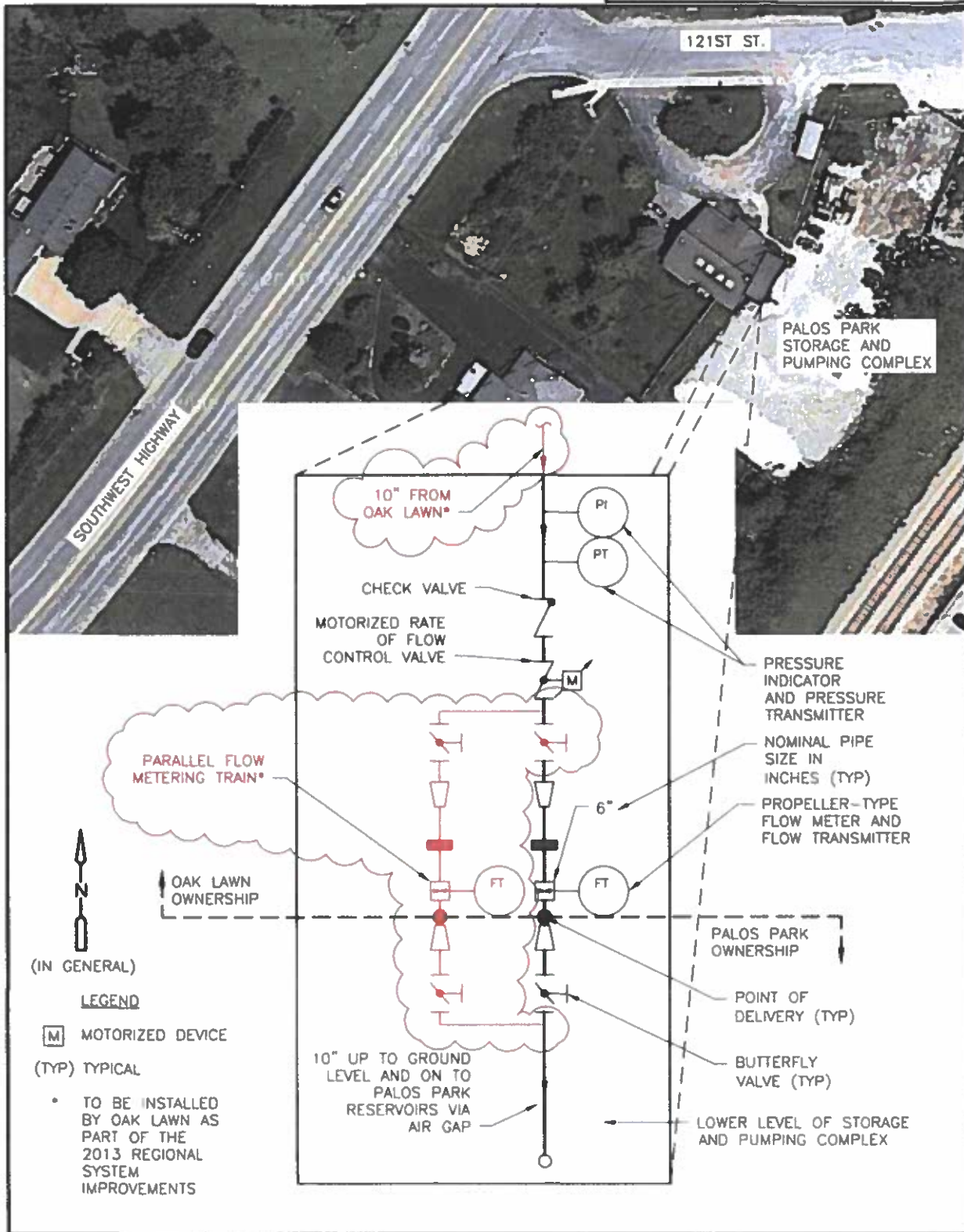

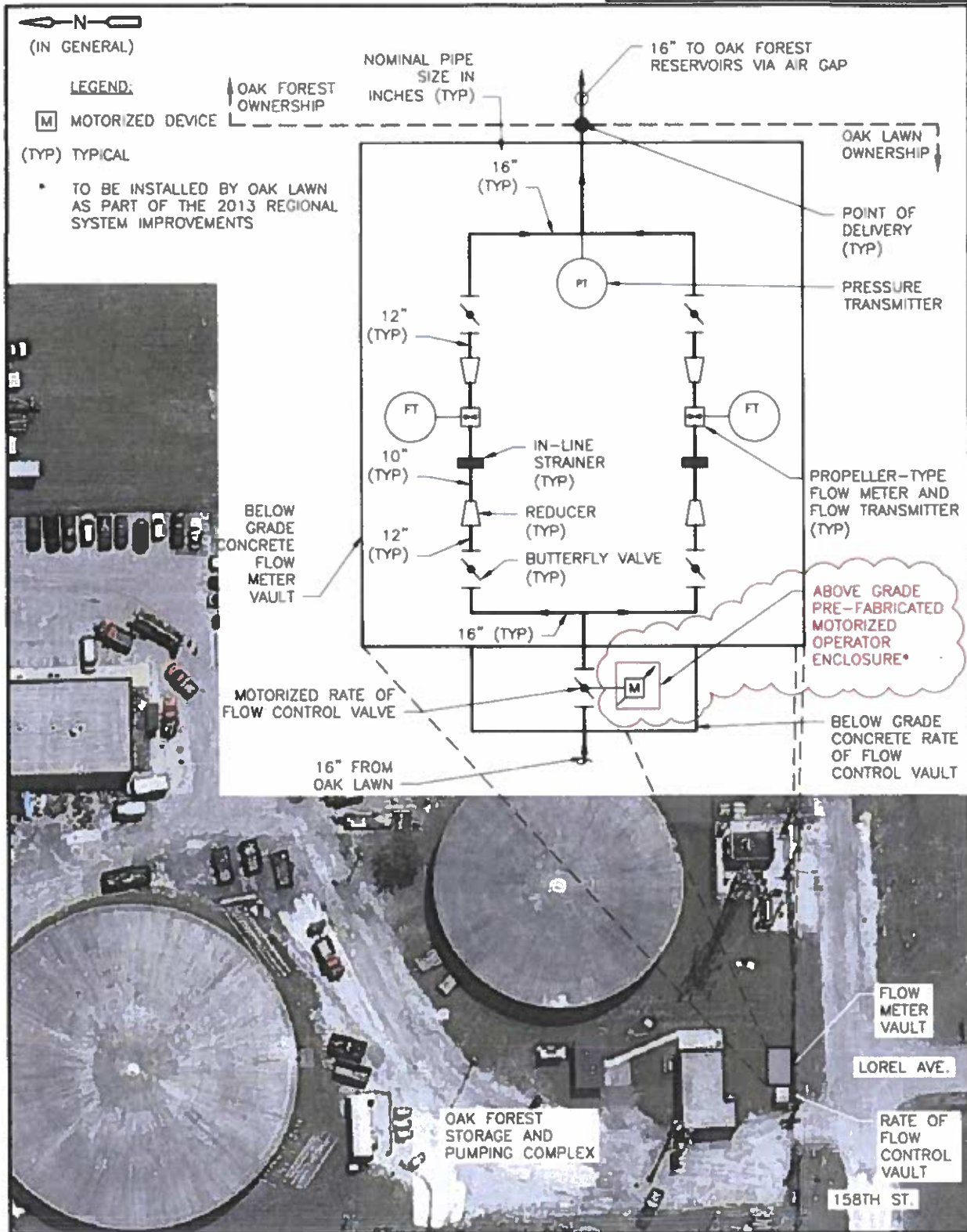

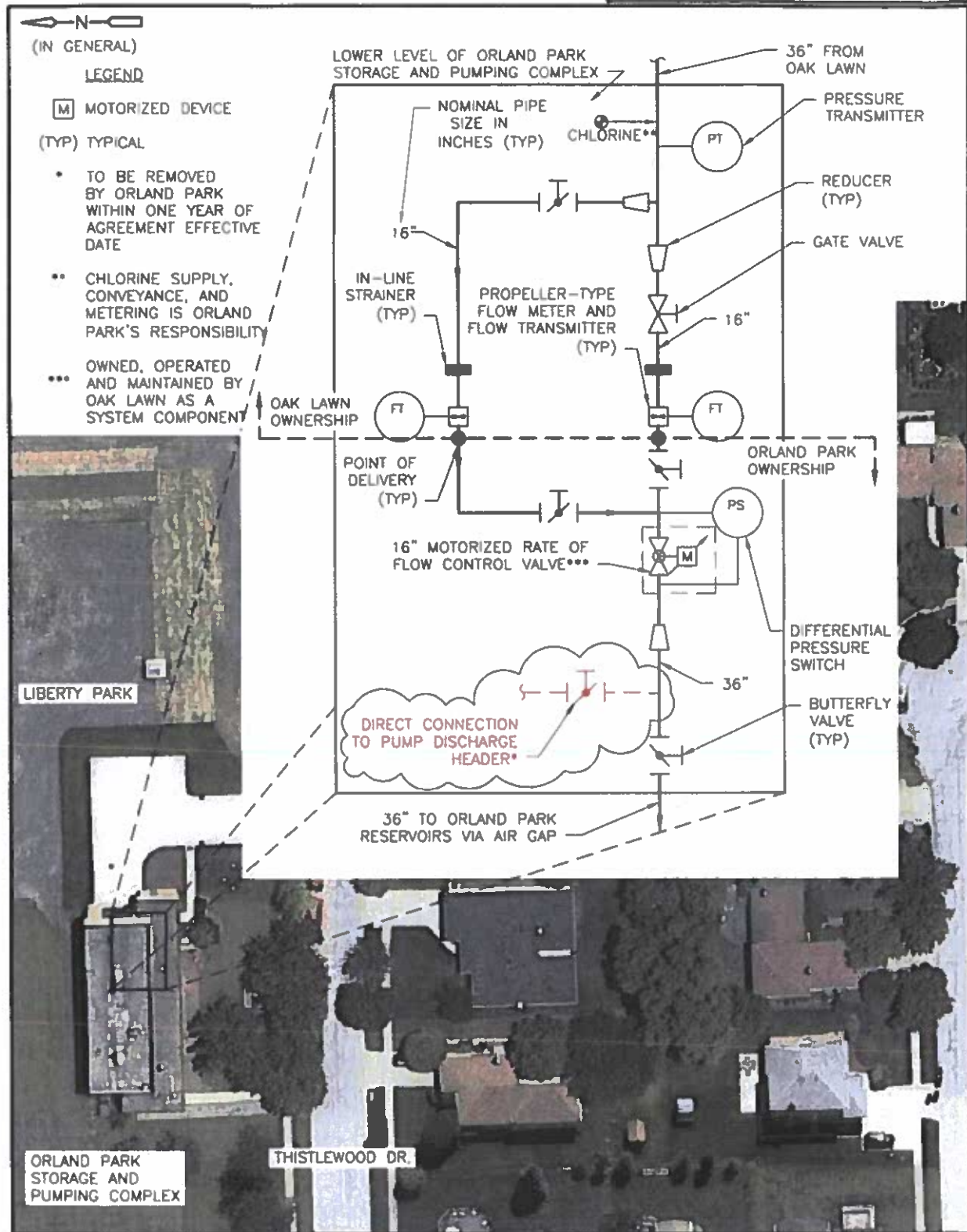

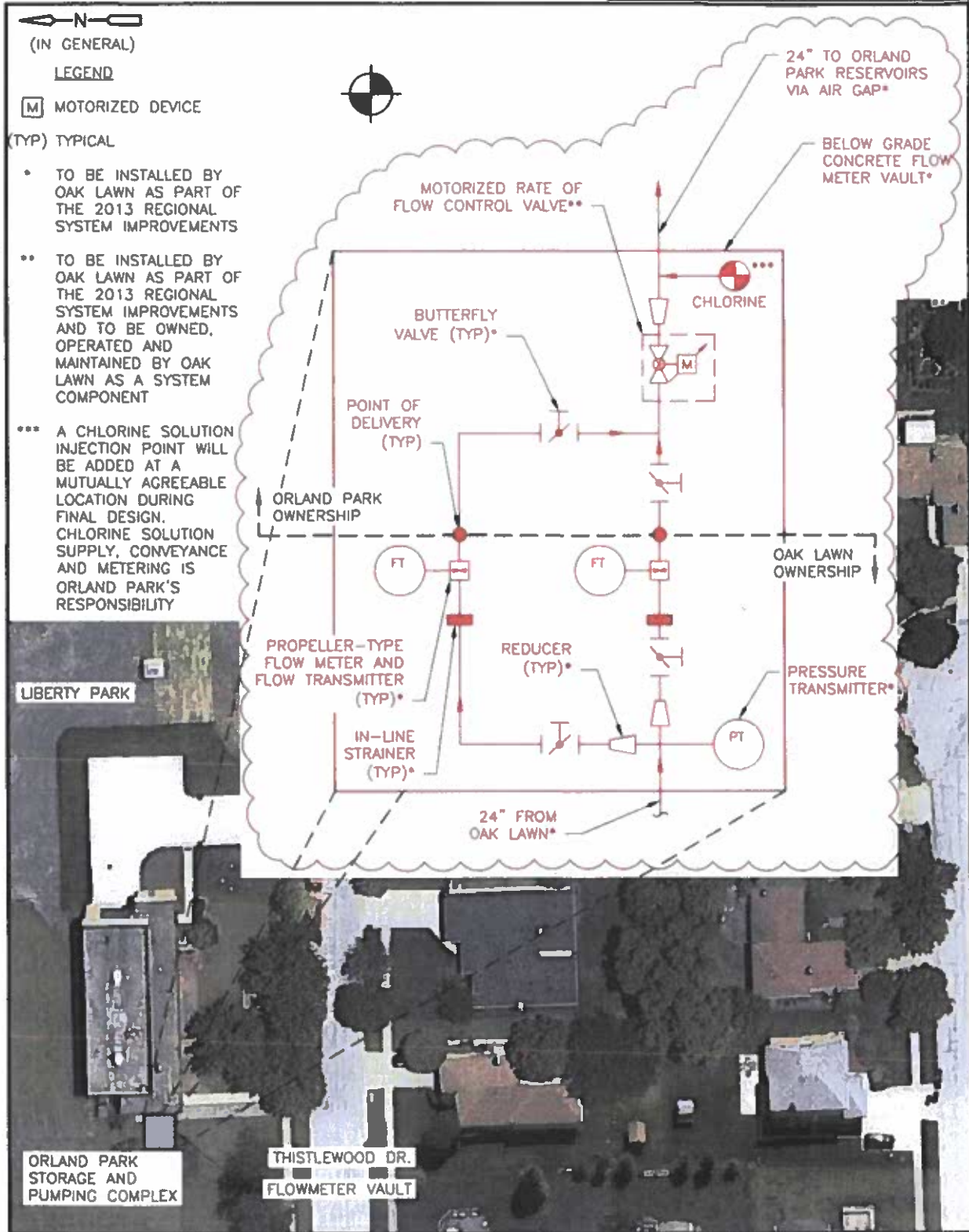

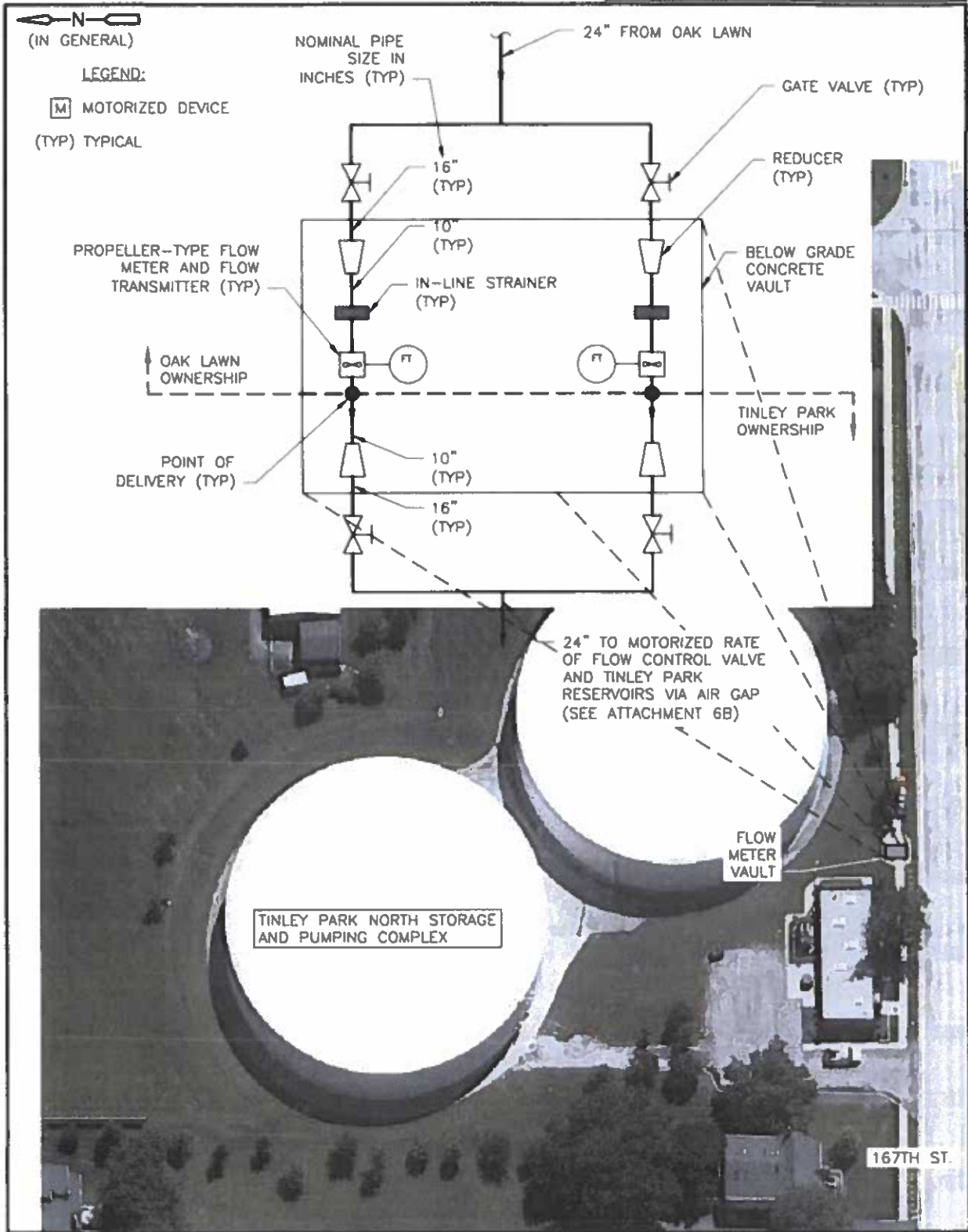

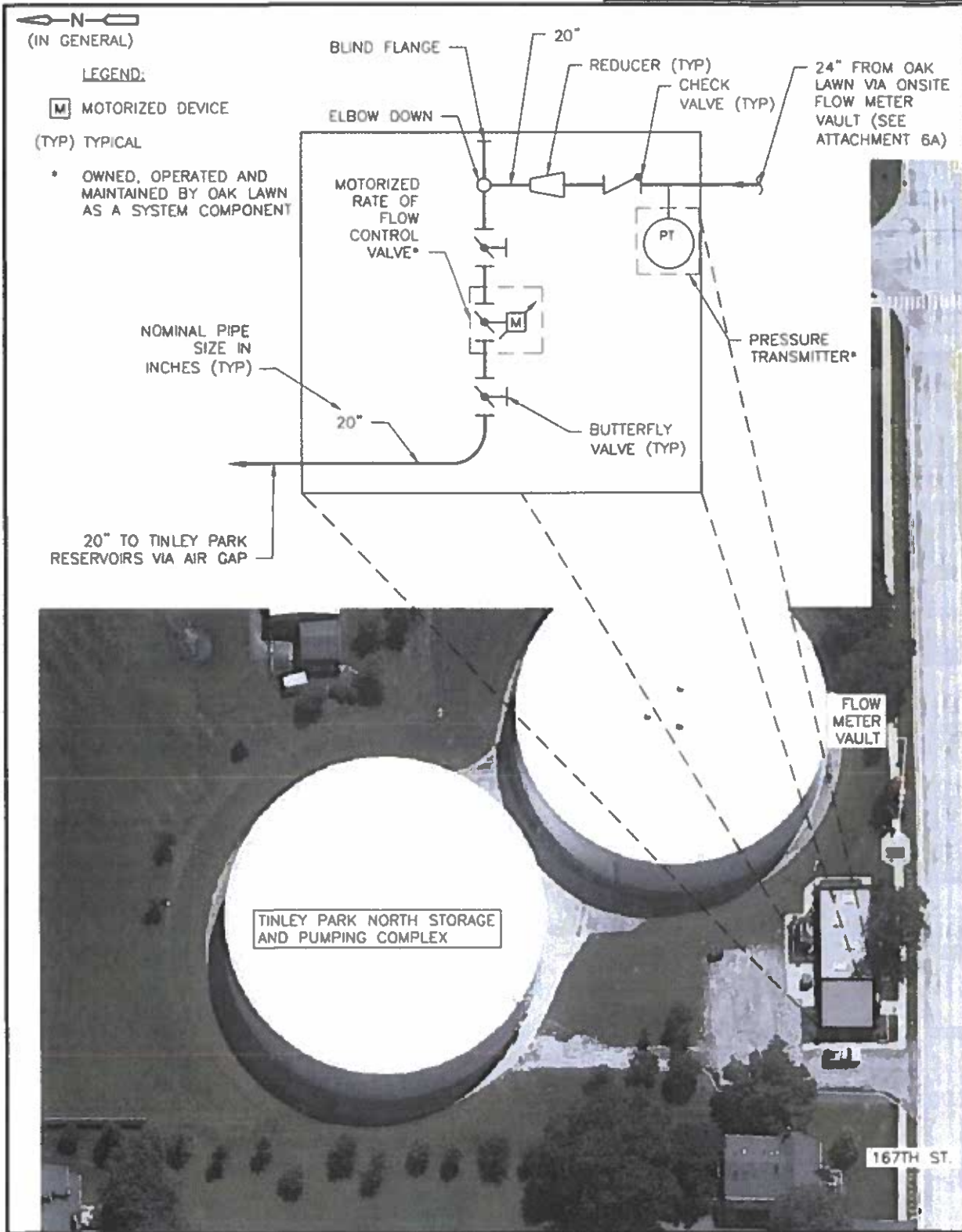

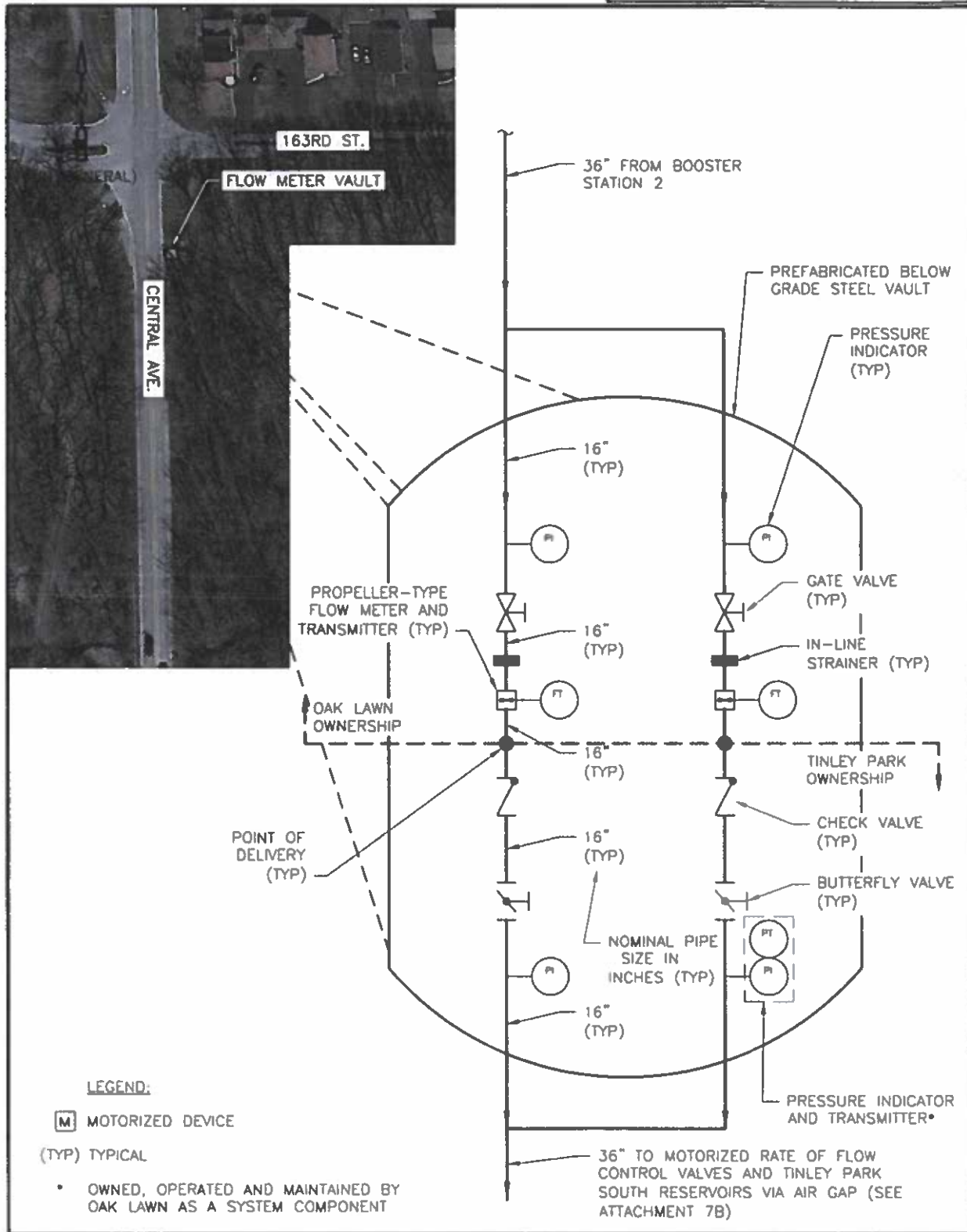

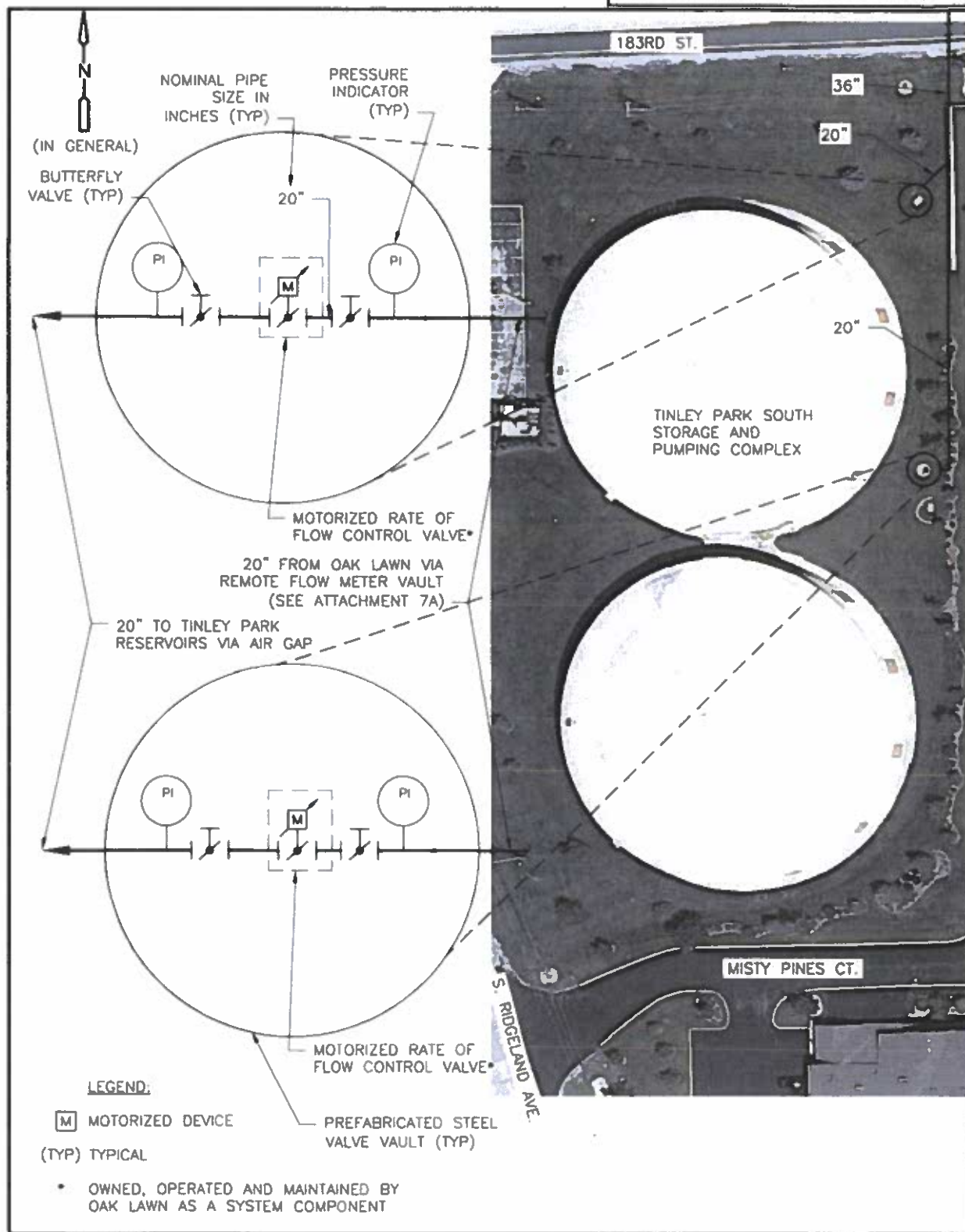

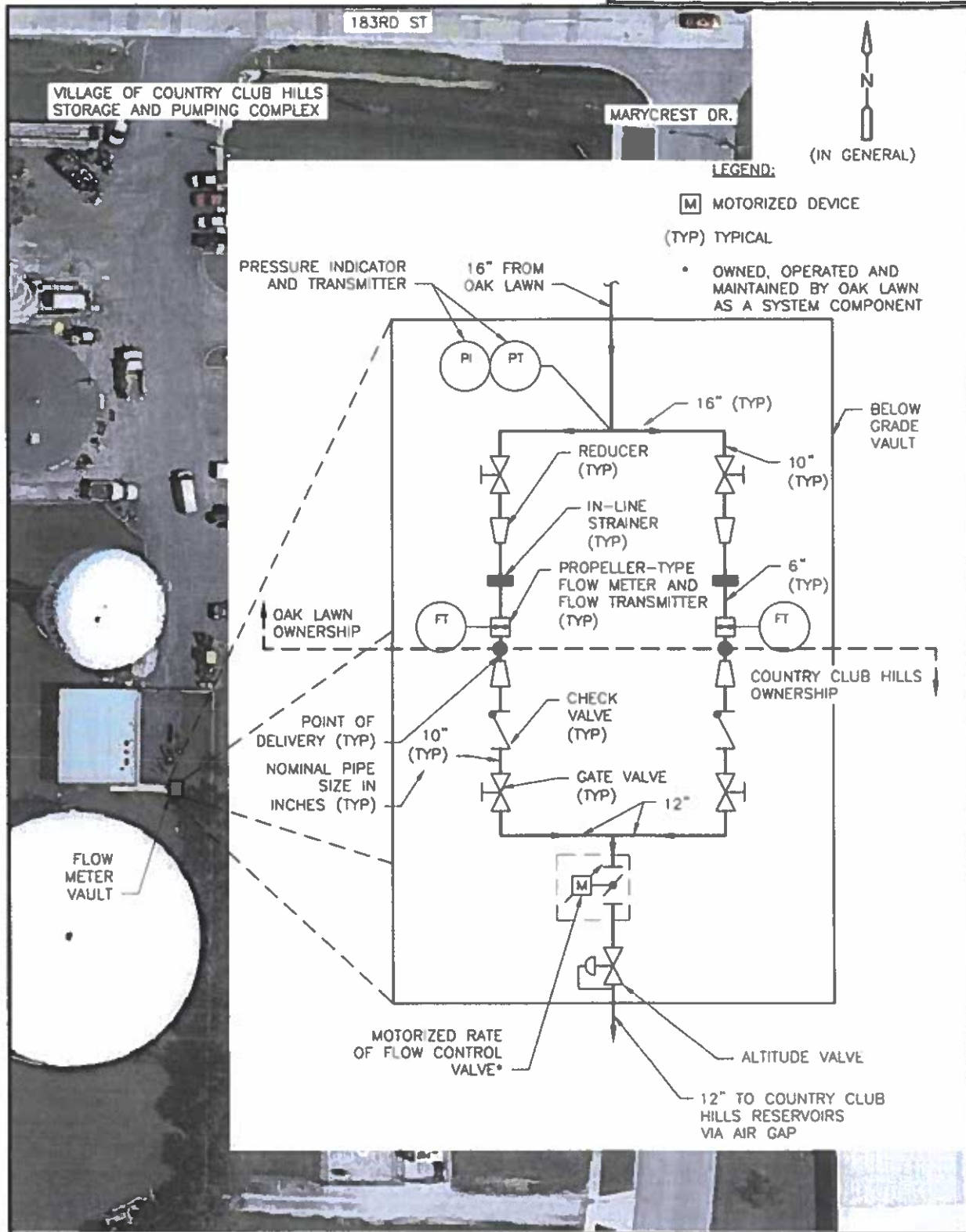

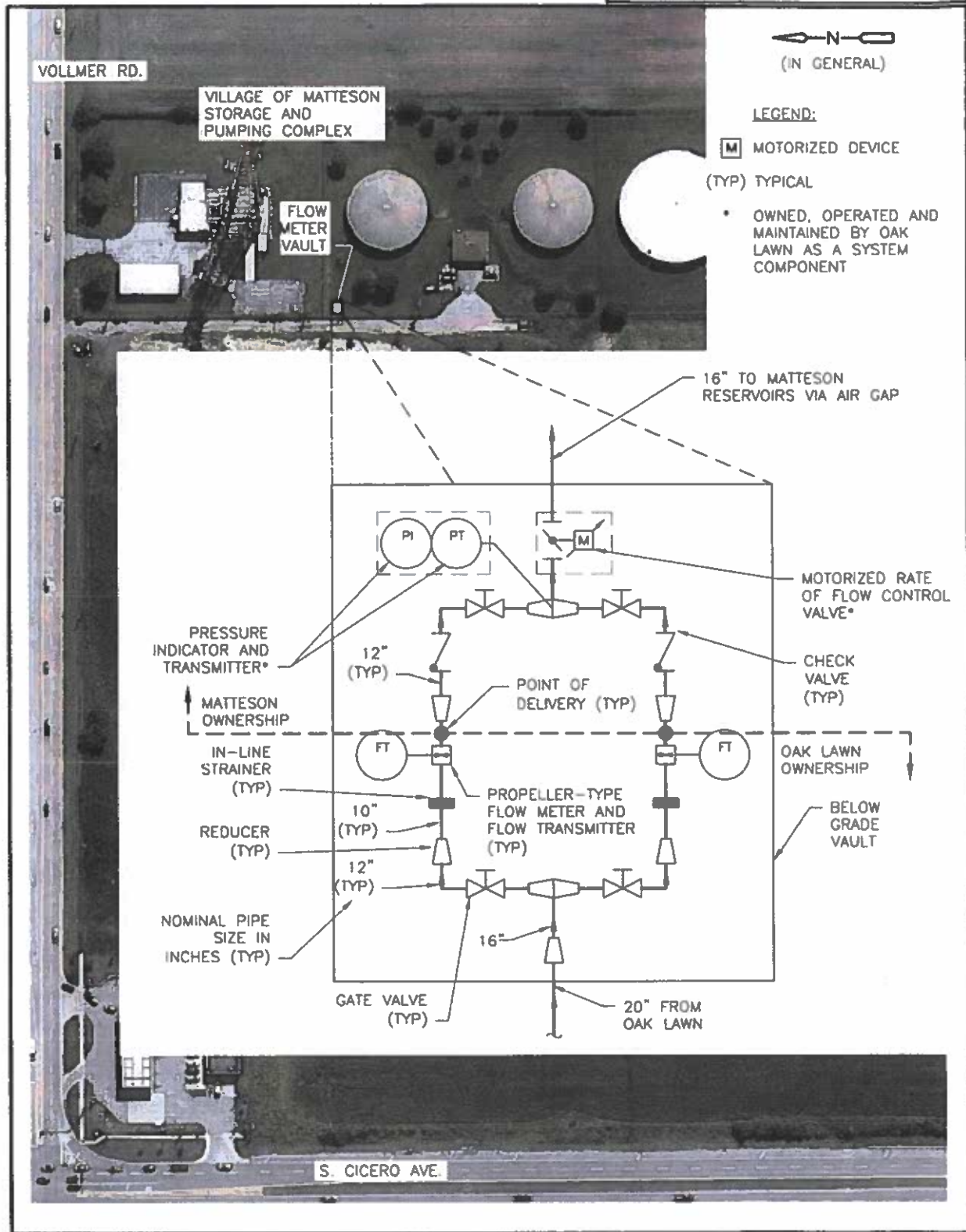

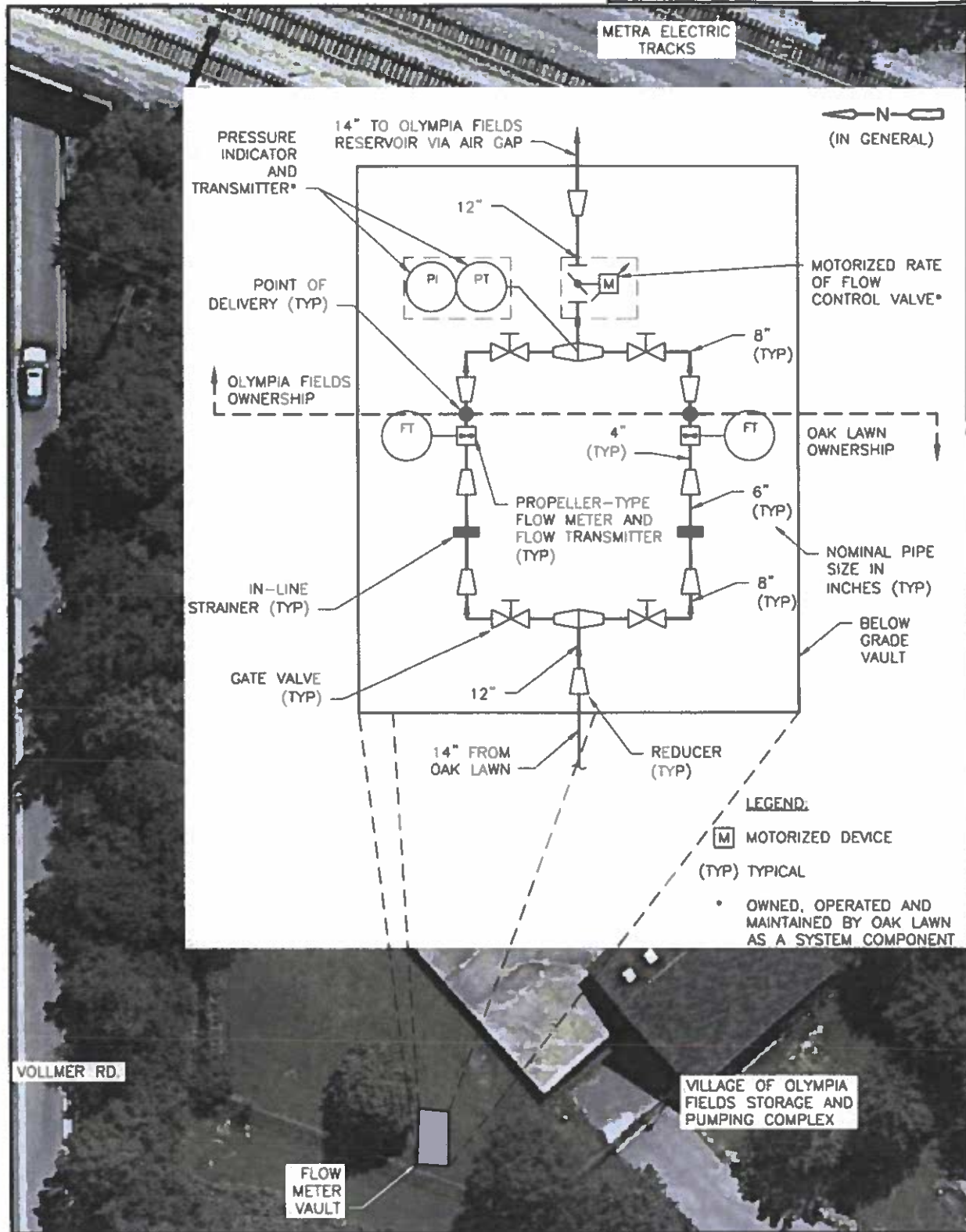

VOLLMER RD.

FLOW METER VAULT

VILLAGE OF OLYMPIA FIELDS STORAGE AND PUMPING COMPLEX

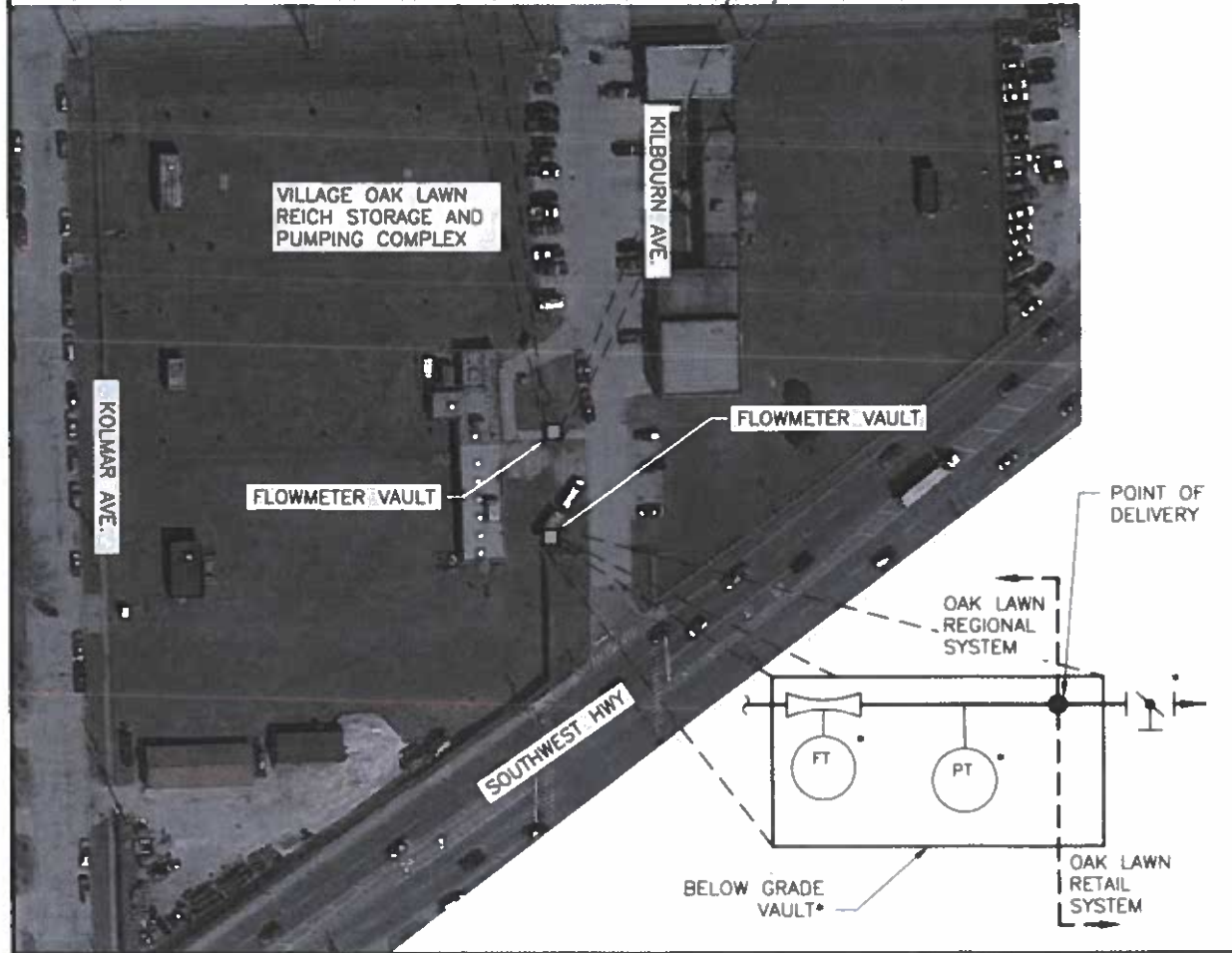
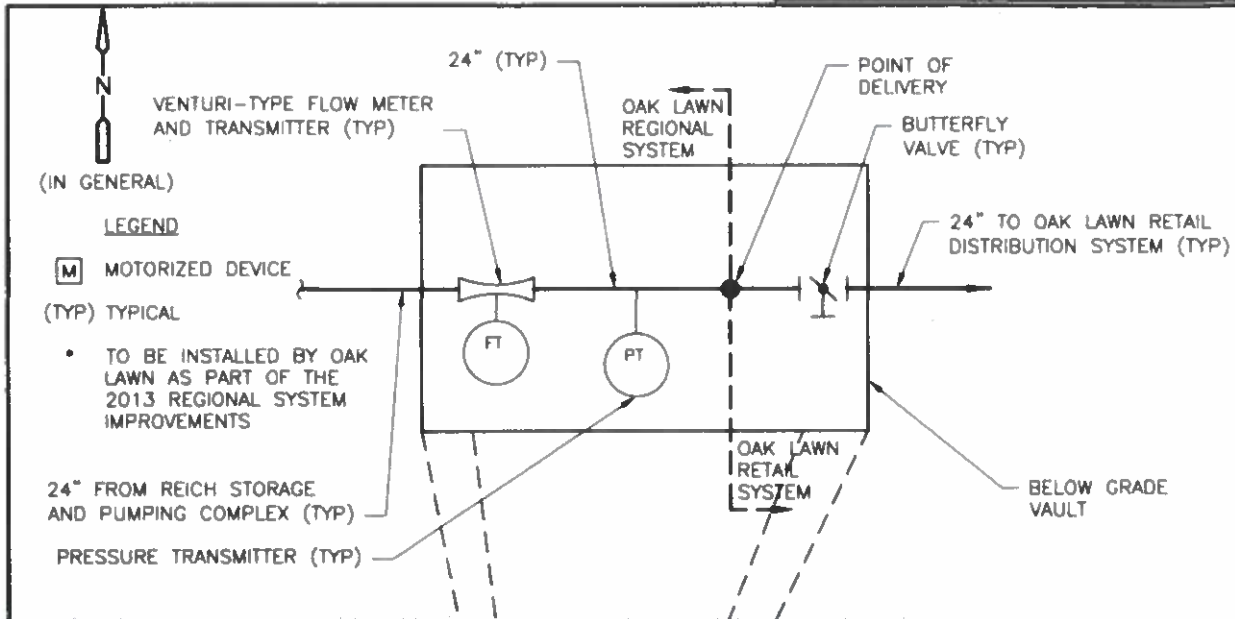

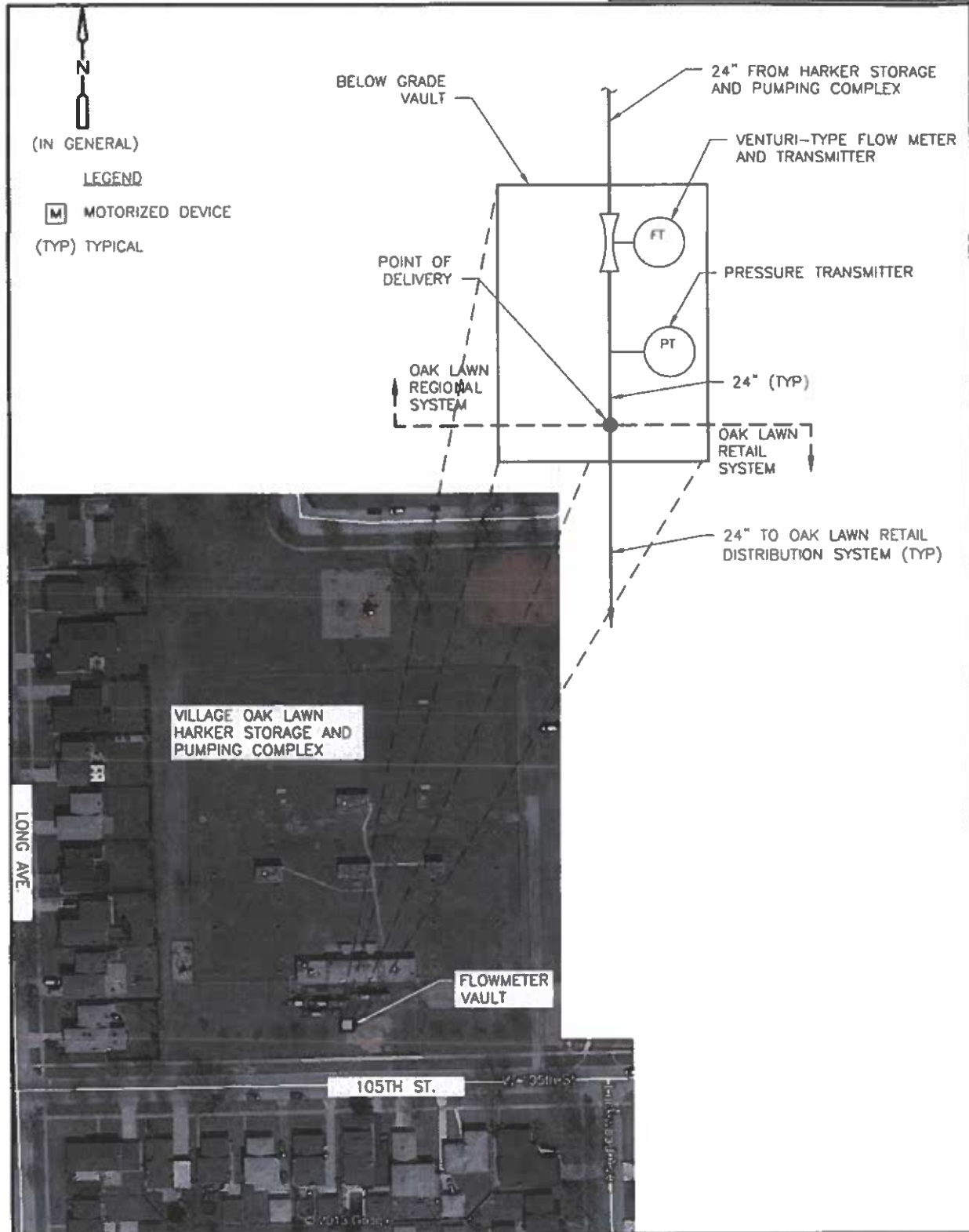

Exhibit C
Description of Existing Oak Lawn Regional Water System
and 2013 Regional System Improvements

The Oak Lawn Regional Water System serves to convey potable water, purchased from the City of Chicago (i.e., Chicago Water), to both the Reich Storage and Pumping Complex and the Harker Storage and Pumping Complex, and to further convey such Chicago Water to Oak Lawn's Municipal Customers, including:

1. Village of Chicago Ridge
2. City of Palos Hills
3. Village of Palos Park
4. Village of Mokena (as served through the Tinley Park Branch System)
5. Village of New Lenox (as served through the Tinley Park Branch System)
6. City of Oak Forest
7. Village of Orland Park
8. Village of Tinley Park
9. City of Country Club Hills (as served through the Oak Lawn Southeast System)
10. Village of Matteson (as served through the Oak Lawn Southeast System)
11. Village of Olympia Fields (as served through the Oak Lawn Southeast System)
12. Village of Oak Lawn (Retail Water System)

The existing Oak Lawn Regional Water System is depicted in schematic form as part of Attachment 1 to this Exhibit and generally consists of:

1. A 17,500 gallon-per-minute (installed capacity) high-service pump station that is currently used to convey Chicago Water from the Reich Storage and Pumping Complex to Chicago Ridge, Palos Hills, Palos Park, and Oak Lawn.
2. A 6,000 gallon-per-minute (installed capacity) high-service pump station that is currently used to convey Chicago Water from the Harker Storage and Pumping Complex to Chicago Ridge, Palos Hills, Palos Park, and Oak Lawn. This pump station will be used upon completion of the herein described improvements to convey Chicago Water only to Chicago Ridge and Oak Lawn.
3. A 48-inch/42-inch transmission main that is currently used to convey Chicago Water from the Harker Storage and Pumping Complex to Orland Park, Oak Forest, Tinley Park, Country Club Hills, Matteson, and Olympia Fields. This transmission main will continue to be used upon completion of the herein described improvements and will be designated as the "East Side" Transmission Main.
4. A 36-inch transmission main that is currently used to convey Chicago Water from the aforementioned 48-inch/42-inch transmission main to Orland Park. This transmission

Description of Existing Oak Lawn Regional Water System and 2013 Regional System Improvements

main will continue to be used upon completion of the herein described improvements and will be designated as the Orland Spur One Main.

5. A 24-inch transmission main that is currently used to convey Chicago Water from the aforementioned 48-inch/42-inch transmission main to Country Club Hills, Matteson, and Olympia Fields. This transmission main will continue to be used upon completion of the herein described improvements as part of the Oak Lawn Southeast System.
6. A 5,600 gallon-per-minute (installed capacity) in-line booster station (Booster Station 1) that is currently used to help convey Chicago Water from the aforementioned 48-inch/42-inch transmission main to Country Club Hills, Matteson, and Olympia Fields. This Booster Station will be expanded and improved to meet the needs of Country Club Hills, Matteson, and Olympia Fields as part of the herein described improvements.
7. An 18,000 gallon-per-minute (installed capacity) in-line booster station (Booster Station 2) that is currently used to help convey Chicago Water from the aforementioned 48-inch/42-inch transmission main to Tinley Park. This Booster Station will be expanded and improved to meet the needs of Tinley Park as part of the herein described improvements.

Anticipated increases in Municipal Customer water demands (through the Year 2030 planning horizon), and the need to eliminate potential single and common mode system failures, has resulted in a plan for the 2013 Regional System Improvements. The 2013 Regional System Improvements serves to benefit all of Oak Lawn's Municipal Customers and includes the following major improvement components, arranged by Bid Package:

Early Out Bid Package: Reich and Harker Motor Control Center, Vault and Valve Modifications, consisting of the following:

- Replacement of the Reich Northern Pressure Zone Pumping Station aged and fault damaged 480V motor control center.
- Replacement of aged pumping unit discharge butterfly valves and addition of electric motor operators to automatically control the discharge valves during pump startup and shutdown operations to mitigate associated surge conditions in the transmission main at Reich Northern Pressure Zone Pumping Station.
- Renovation/replacement of electrical conduit and wiring within the Reich flow meter vault (one vault).
- Renovation/replacement of electrical conduit and wiring within the Harker flow meter and valve vaults (four total vaults).

Bid Package No. 1: Modifications at Harker Complex, consisting of the following:

- Addition of 1-1,000 HP (12,000 gpm) pumping unit to replace Southern Pressure Zone Pump 10 (500 HP), including new variable frequency drive and associated control system, and addition of 36-inch FLOW 2 Venturi with associated vault improvements.
- Replacement of manual operators on pump discharge butterfly valves with electric motor operators to automatically control the discharge valves during pump startup and shutdown operations to mitigate associated surge conditions in the transmission main (Harker Southern Pressure Zone and Northern Pressure Zone pumps).
- Addition of Electrical Room at Pumping Station, replacement of existing Pumping Station roof, and replacement of aged HVAC equipment.
- Addition of surge tank connected to the SPZ transmission main as it exits the site to protect the main from high vacuum and pressure conditions.
- Addition of surge relief valve for the NPZ discharge header.
- Expansion of a groundwater dewatering system to help protect the structural integrity of the reservoirs and allow for periodic inspection and maintenance .
- Addition of 1-2,500 kW standby engine generator, permanently installed and capable of powering 1-1,000 HP (12,000 gpm) SPZ pumping unit, 1-200 HP (3,000 gpm) NPZ pumping unit, plus building HVAC and lighting loads.
- Addition of a gaseous chlorine dry-type absorption scrubber to mitigate inadvertent chlorine gas releases.
- Addition of four motor operated flow control valves to control flow from the City of Chicago to the Harker Complex and to dissipate energy upon delivery.
- Addition of reservoir interconnections to accommodate design flow conveyance through the reservoirs and allow the reservoirs to be isolated for maintenance and repair
- Addition of reservoir overflow improvements .
- Addition of updated perimeter fencing, and surveillance cameras to improve security.
- Addition of screen wall and ornamental fencing to improve aesthetics.

Bid Package No. 2: Modifications at Reich Complex and Points of Delivery, consisting of the following:

Reich Complex

- Addition of 1-250 kW hydroelectric turbine at Pumping Station inlet to capture available residual energy and convey the energy into the Reich Complex "internal" grid (building costs apportioned by area required).
- Addition of a groundwater dewatering system to allow for periodic reservoir inspection and maintenance.

Description of Existing Oak Lawn Regional Water System and 2013 Regional System Improvements

- Addition of reservoir interconnections and bypass piping to accommodate design flow conveyance through the reservoirs and allow the reservoirs to be isolated for maintenance.
- Addition of a new Reich SPZ Pumping Station, including the addition of 4-1,000 HP (11,000 gpm each) pumping units, VFDs, soft starters, and associated control systems (building costs apportioned by area required).
- Addition of second discharge header connection to the NPZ to eliminate a single point of failure condition and a surge relief valve to protect the main from high vacuum and pressure conditions, and replacement of Pumping Station roof.
- Addition of surge tank connected to the SPZ transmission main as it exits the site to protect the main from high vacuum and pressure conditions.
- Addition of 1-2,500 kW standby engine generator, permanently installed and capable of powering 1-1,000 HP (11,000 gpm) SPZ pumping unit, 1-200 HP (4,000 gpm) NPZ pumping unit, plus building HVAC and lighting loads at the new Reich SPZ Pumping Station.
- Addition of a gaseous chlorine dry-type absorption scrubber to mitigate inadvertent chlorine gas releases.
- Addition of updated perimeter fencing, and surveillance cameras to improve security.
- Addition of ornamental fencing to improve aesthetics.

Points of Delivery and System-wide SCADA Improvements

- Replacement of obsolete PLCs at points of delivery, including communication equipment and associated programming.
- Replacement of existing "top-end" HMI software with a less proprietary SCADA platform
- Provision and installation of a database management system historian.
- Configuration of a firewall-protected website that permits authorized staff and customers to view Regional Water System operating parameters.

Bid Package No. 3: Booster Pumping Station Nos. 1 and 2 Improvements, consisting of the following:

- Provision of 1-300 kW portable standby engine generator to provide emergency power to the Booster Stations in the event of a utility power outage.

Booster Pumping Station No. 1

- Demolition of existing booster station and construction of a new above grade prefabricated pumping station, including 4-125 HP (3,000 gpm each) pumping units (2 variable speed, 2 constant speed) and construction of tie-ins to redundant 24-inch transmission main at the suction and discharge sides of the Station.

Booster Pumping Station No. 2

- Addition of 2-150 HP (6,000 gpm each) pumping units and construction of tie-ins to redundant 42-inch transmission main at the suction and discharge sides of the Station.

Bid Package No. 4: Transmission Main – 60-inch from Reich Complex to Cal-Sag Channel Crossing, consisting of the following:

- Construction of 60-inch transmission main from Reich Storage and Pumping Complex to northern bank of Cal-Sag Channel.
- Obtaining associated easements – total cost apportioned by lineal feet of transmission main.

Bid Package Nos. 5 and 6: Transmission Main – 60-inch Cal-Sag Channel Crossing and through ComEd Corridor to, consisting of the following:

- Construction of 60-inch transmission main beneath Cal-Sag Channel, to 151st Street via ComEd Corridor and Cook County's Forest Preserve.
- Obtaining associated easements – total cost apportioned by lineal feet of transmission main (ComEd easement costs are included, but anticipated corridor use cost has yet to be negotiated with the Forest Preserve District of Cook County and is not included).

Bid Package No. 7: Transmission Main – 24-inch Connection to Orland Park and 36/42-inch Cross-Town Connection to Booster Pumping Station No. 2, consisting of the following:

- Construction of 24-inch transmission main connection to Orland Park from new West Side transmission main (Orland Spur Two Main).
- Construction of 24-inch Cross-Town transmission main along 151st Street from the ComEd Corridor east to Oak Park Avenue; construction of 36-inch Cross Town transmission main from 151st Street/Oak Park Avenue to 159th Street/Central Avenue and connection to existing 42-inch East Side transmission main.
- Construction of 42-inch redundant transmission main from 159th Street/Central Avenue to Booster Station No. 2.

Bid Package No. 8: Transmission Main – 16-inch Connection to Palos Hills and 10-inch Connection to Palos Park, consisting of the following:

- Construction of a new 16-inch transmission main to Palos Hills from the new 60-inch West Side Transmission Main.
- Construction of a new 10-inch transmission main to Palos Park from the new 60-inch West Side Transmission Main.

The Oak Lawn Regional Water System, as it is planned to exist, after design and construction of the 2013 Regional System Improvements, is depicted in schematic form as part of Attachment 2 to this Exhibit.

In general, and dependent on the Effective Date of the Agreement (assumed to be April 1, 2014 for purpose of scheduling), implementation of the 2013 Regional System Improvements is envisioned to progress from design through construction in accordance with the following schedule:

<u>Bid Package</u>	<u>Design Start Date</u>	<u>Construction Bid Date</u>	<u>Construction Completion Date</u>
1. Harker Storage and Pumping Complex	January 2013	August 9, 2013	July 2016
2. Reich Storage and Pumping Complex	January 2013	February 21, 2014	June 2017
3. Booster Stations 1 and 2	April 2014	July 15, 2016	April 2018
4. Transmission Main: 60-inch from Reich Complex along Southwest Highway to Calumet-Sag Channel	April 2014	September 1, 2016	December 2018
5. Transmission Main: 60-inch Crossing of the Calumet-Sag Channel	April 2014	September 1, 2016	December 2018
6. Transmission Main: 60-inch along Commonwealth Edison Corridor from Calumet-Sag Channel to 151 st Street	April 2014	September 1, 2016	December 2018

Exhibit C
Description of Existing Oak Lawn Regional Water System and 2013 Regional System Improvements

<u>Bid Package</u>	<u>Design Start Date</u>	<u>Construction Bid Date</u>	<u>Construction Completion Date</u>
7. Transmission Main: Cross-Town Connections to Orland Park and Booster Pumping Station No. 2	April 2014	September 1, 2016	April 2018
8. Transmission Main: Connections to Palos Hills and Palos Park	April 2014	September 1, 2016	April 2018

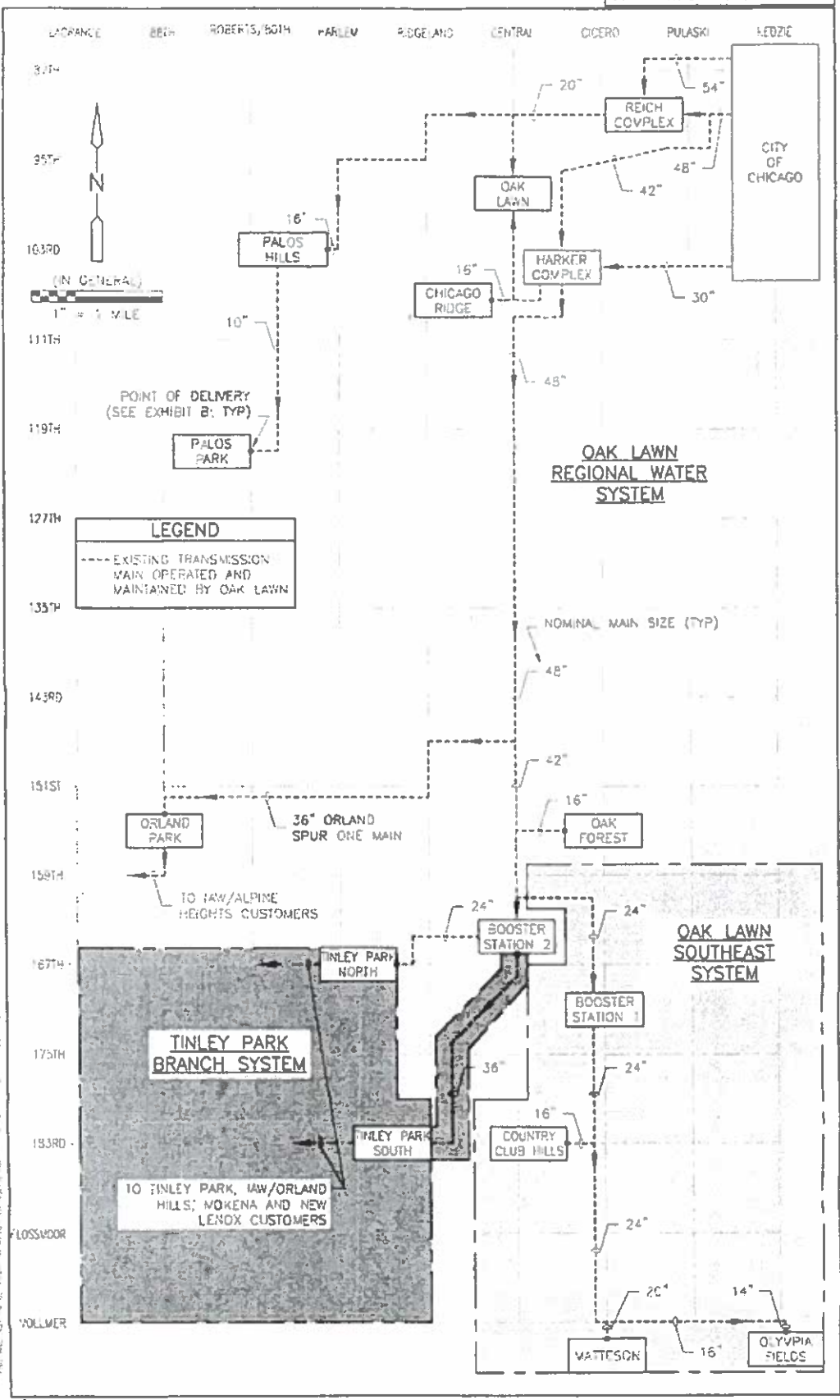

ALL INFORMATION CONTAINED HEREIN IS UNCLASSIFIED EXCEPT WHERE SHOWN OTHERWISE. IT IS THE PROPERTY OF CDM SMITH AND IS NOT TO BE REPRODUCED OR TRANSMITTED IN ANY FORM OR BY ANY MEANS, ELECTRONIC OR MECHANICAL, INCLUDING PHOTOCOPYING, RECORDING, OR BY ANY INFORMATION STORAGE AND RETRIEVAL SYSTEM.

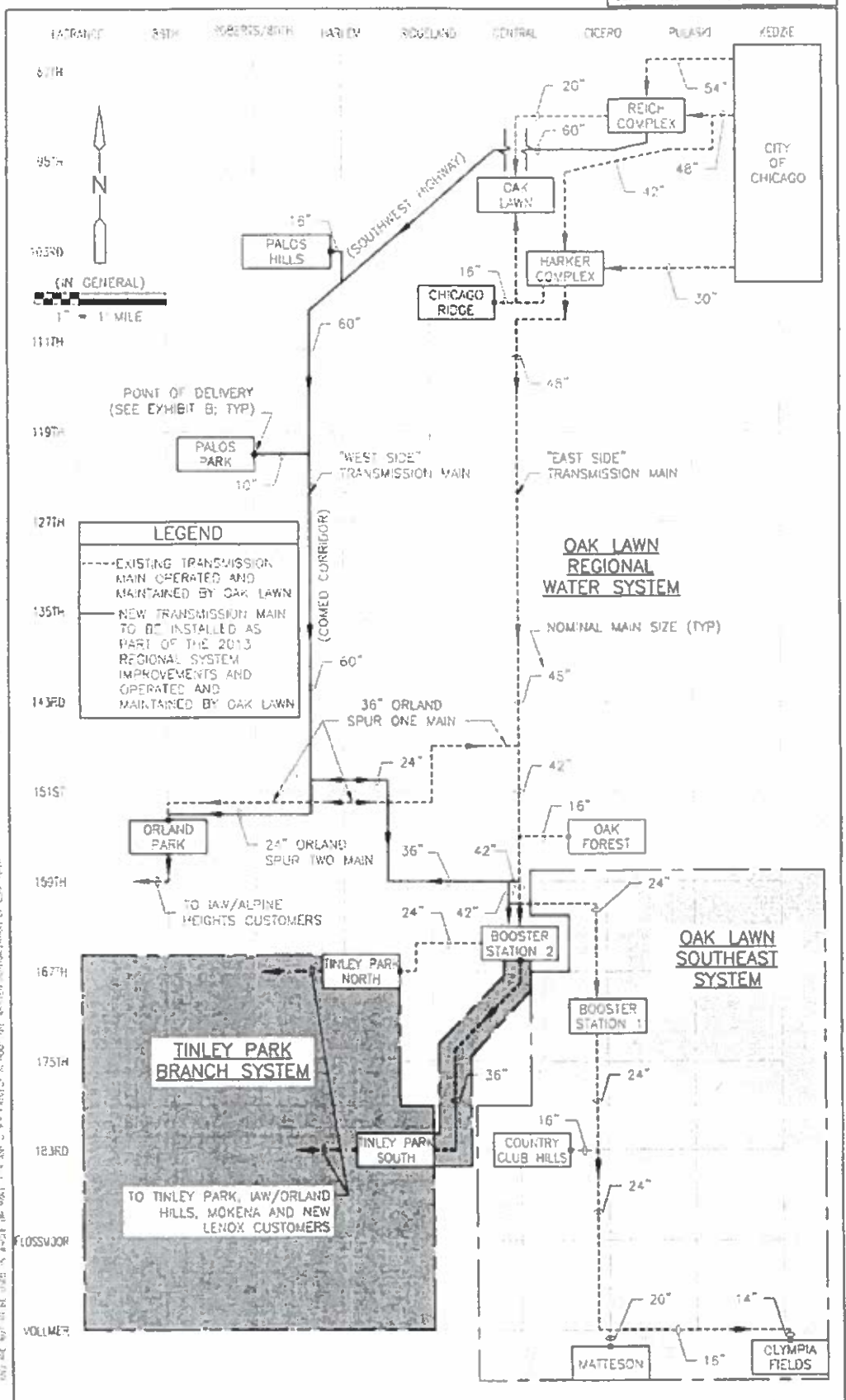

EXISTING OAK LAWN REGIONAL WATER SYSTEM TRANSMISSION MAINS, THESE TRANSMISSION MAINS TO BE REPLACED OR IMPROVED AS PART OF THE 2013 REGIONAL SYSTEM IMPROVEMENTS AND OPERATED AND MAINTAINED BY OAK LAWN.

Exhibit C-1



Village of Oak Lawn Water Transmission Main Bid Packages 7A & 7B - Revised Alignments



Exhibit D

Municipal Customers' IDNR Approved Lake Michigan Water Allocations and Contractual Service Requirements

Municipal Customer	Chicago Ridge	Palos Hills	Palos Park	Mokena	New Lenox	Oak Forest	Orland Park (Including Illinois American-Alpine Heights)	Tinley Park (Including Illinois American-Arbury and Orland Hills ⁽¹⁾)
Daily Peaking Factor	2	2	2	2	2	2	2	2
Year 2030 IDNR Approved Lake Michigan Water Allocation by Year (MGD)								
2010	1,523	1,967	0,572	2,293	2,594	2,981	8,164	7,330
2011	1,524	1,971	0,585	2,419	2,747	3,002	8,273	7,471
2012	1,525	1,974	0,597	2,546	2,899	3,022	8,381	7,613
2013	1,526	1,977	0,610	2,670	3,037	3,043	8,490	7,754
2014	1,527	1,981	0,623	2,795	3,184	3,063	8,598	7,895
2015	1,528	1,984	0,635	2,921	3,332	3,084	8,707	8,037
2016	1,529	1,985	0,648	3,047	3,479	3,104	8,815	8,179
2017	1,529	1,991	0,661	3,162	3,627	3,125	8,924	8,348
2018	1,530	1,995	0,673	3,283	3,774	3,145	9,033	8,504
2019	1,531	1,998	0,686	3,403	3,922	3,165	9,141	8,659
2020	1,532	2,001	0,699	3,524	4,069	3,186	9,250	8,815
2021	1,533	2,005	0,711	3,645	4,217	3,206	9,358	8,961
2022	1,534	2,008	0,724	3,766	4,364	3,227	9,467	9,108
2023	1,535	2,012	0,737	3,888	4,512	3,247	9,575	9,254
2024	1,536	2,015	0,749	4,009	4,659	3,268	9,684	9,401
2025	1,537	2,019	0,762	4,130	4,807	3,288	9,792	9,547
2026	1,537	2,022	0,775	4,252	4,954	3,309	9,901	9,693
2027	1,537	2,025	0,787	4,374	5,102	3,329	10,009	9,840
2028	1,537	2,029	0,800	4,496	5,249	3,349	10,118	9,986
2029	1,537	2,032	0,813	4,618	5,397	3,370	10,226	10,133
2030	1,537	2,036	0,825	4,740	5,544	3,390	10,335	10,279
Year 2031 Through Term of Agreement:	1,537	2,036	0,825	4,740	5,544	3,390	10,335	10,279

Municipal Customer	Country Club Hills	Matteson	Olympia Fields	Oak Lawn	Total Year 2030 IDNR Approved System Allocation - MGD	Total Regional System Capacity Required - MGD	Total Regional System Design Capacity - MGD	Oak Lawn Reserve Share Capacity - MGD	Total Spare Available Capacity - MGD
Daily Peaking Factor	2 ⁽²⁾	2 ⁽²⁾	2 ⁽²⁾	2					
Year 2030 IDNR Approved Lake Michigan Water Allocation by Year (MGD)									
2010	1,447	2,209	0,878	7,082	28,991	78.0	55.0	0.0	-23.0
2011	1,458	2,286	0,841	7,109	31,680	79.4	55.0	0.0	-24.4
2012	1,469	2,361	0,834	7,136	40,369	80.7	55.0	0.0	-25.7
2013	1,481	2,440	0,867	7,163	41,058	82.1	55.0	0.0	-27.1
2014	1,492	2,517	0,880	7,190	41,747	83.5	55.0	0.0	-28.5
2015	1,503	2,594	0,893	7,217	42,435	84.9	55.0	0.0	-29.9
2016	1,515	2,671	0,906	7,243	43,027	86.1	55.0	0.0	-31.1
2017	1,526	2,749	0,908	7,269	43,618	87.2	55.0	0.0	-32.2
2018	1,537	2,826	0,915	7,295	44,210	88.4	55.0	0.0	-33.4
2019	1,548	2,901	0,923	7,321	44,801	89.6	111.0	5.0	-16.4
2020	1,560	2,980	0,930	7,347	45,392	90.8	111.0	5.0	-15.2
2021	1,572	3,057	0,943	7,363	45,982	91.8	111.0	5.0	-14.2
2022	1,582	3,134	0,956	7,380	46,431	92.9	111.0	5.0	-13.1
2023	1,594	3,211	0,969	7,397	46,951	93.9	111.0	5.0	-12.1
2024	1,605	3,288	0,982	7,414	47,470	94.9	111.0	5.0	-11.1
2025	1,616	3,365	0,995	7,431	47,989	96.0	111.0	5.0	-10.0
2026	1,627	3,442	1,007	7,445	48,508	97.0	111.0	5.0	-9.0
2027	1,638	3,519	1,019	7,460	49,027	98.1	111.0	5.0	-7.9
2028	1,650	3,595	1,032	7,474	49,546	99.1	111.0	5.0	-6.9
2029	1,662	3,672	1,045	7,489	50,065	100.1	111.0	5.0	-5.9
2030	1,672	3,748	1,057	7,503	50,583	101.2	111.0	5.0	-4.8
Year 2031 Through Term of Agreement:	1,672	3,748	1,057	7,503	50,583	101.2	111.0	5.0	4.8

Notes

⁽¹⁾ Orland Hills is referred to as Illinois American - Fernway by the IDNR for 2030 Allocation purposes

⁽²⁾ A Daily Peaking Factor of two (2) cannot be provided to Country Club Hills, Matteson, and Olympia Fields without further improvements to the Oak Lawn Southeast System. Such improvement is above and beyond that provided by the 2012 Regional System Improvements.



Exhibit E
Proportionate Shares of Capital Costs and Charges

Municipal Customer	Share of Oak Lawn Regional Water System Costs Allocated to Municipal Customers Without Southeast System Customer Participation (Alternative 1)	Share of Oak Lawn Regional Water System Costs Allocated to Municipal Customers (Alternative 2)
Chicago Ridge	0.675%	0.576%
Palos Hills	5.629%	4.804%
Palos Park	2.219%	1.894%
Mokena	7.995%	6.823%
New Lenox	13.679%	11.674%
Oak Forest	7.754%	6.618%
Orland Park (including Illinois American - Alpine Heights)	26.421%	22.549%
Tinley Park (including Illinois American - Arbury and Orland Hills ⁽¹⁾)	23.923%	20.417%
Country Club Hills	0.000%	3.783%
Matteson	0.000%	8.481%
Olympia Fields	0.000%	2.392%
Oak Lawn	11.704%	9.989%
Totals	100.00%	100.00%

Notes:

⁽¹⁾Orland Hills is referred to as "Illinois American - Fernway" by IDNR for 2030 allocation purposes.



Exhibit E
Proportionate Share Calculation Methodology
(Oak Lawn Regional Water System Capital Costs and Charges)

I. PROPORTIONATE SHARE RATIONALE

- A. All Oak Lawn Regional Water System (System) costs need to be captured and fairly allocated based on benefit received and/or burden placed on the System.
- B. Municipal Customers that benefit from a given Component should pay a Component cost share in proportion to the benefit they receive from that Component.
- C. A Municipal Customer's 2030 Allocation, as a portion of all Municipal Customer 2030 Allocations, can be used to determine a Municipal Customer's Proportionate Share of the cost of a Component.

II. CALCULATION METHODOLOGY

- A. Determine whether a given Component directly benefits a given Municipal Customer. The estimated cost of the 2013 Regional System Improvements and the Municipal Customers that benefit from specific Components of the 2013 Regional System Improvements are listed in Attachment 1 to this Exhibit.
- B. Divide the benefiting Municipal Customer's 2030 Allocation by the total 2030 Allocation of all benefiting Municipal Customers.
- C. Multiply the result of "B" above by 100% as follows to determine each Municipal Customer's Share of Capital Costs and Charges:

$$\begin{array}{c}
 \text{MUNICIPAL} \\
 \text{CUSTOMER'S} \\
 \text{PROPORTIONATE} \\
 \text{SHARE OF CAPITAL} \\
 \text{COSTS AND} \\
 \text{CHARGES}
 \end{array}
 \cdot \frac{
 \left(\begin{array}{c}
 \text{BENEFITING MUNICIPAL CUSTOMER'S} \\
 \text{2030 ALLOCATION}
 \end{array} \right)
 }{
 \left(\begin{array}{c}
 \text{TOTAL OF ALL BENEFITING MUNICIPAL} \\
 \text{CUSTOMER YEAR 2030 ALLOCATIONS}
 \end{array} \right)
 }
 \times (100\%)$$

Exhibit F Allocation of Electricity Costs

Municipal Customer Modeled Year 2030 Average Dry Demand Conditions ⁽¹⁾	Chicago Ridge	Palos Hills	Palos Park	Oak Forest	Orland Park ⁽²⁾	Tinley Park ⁽³⁾ , Mokena ⁽⁴⁾ , and New Lenox ⁽⁴⁾
Year 2030 IDNR Approved Lake Michigan Allocation	1,537	2,036	0,325	3,190	10,335	15,480
Reich/Harker Discharge Pressure (PSI)	59	102	102	102	102	102
Residual Pressure at Point of Delivery (PSI)	53	101	91	67	59	37
Pressure Consumed for Delivery (PSI)	6	1	11	30	43	65
Minimum Pressure Required at Point of Delivery (PSI)	20	20	20	20	20	20
Total Pressure Required for Delivery (PSI)	26	21	31	60	63	85
Electric Horsepower Utilized for Delivery (EHP)	22	23	14	110	352	349
Share of Actual Electricity Cost Allocated to Municipal Customers	1.13%	1.21%	0.72%	5.74%	18.38%	44.34%

Municipal Customer Modeled Year 2030 Average Dry Demand Conditions ⁽¹⁾	Country Club Hills	Matteson	Olympia Fields	Oak Lawn	Totals
Year 2030 IDNR Approved Lake Michigan Allocation	1,672	1,748	1,057	7,503	12,980
Reich/Harker Discharge Pressure (PSI)	102	102	102	59	
Residual Pressure at Point of Delivery (PSI)	24	33	43	37	
Pressure Consumed for Delivery (PSI)	78	69	60	22	
Minimum Pressure Required at Point of Delivery (PSI)	20	20	20	35	
Total Pressure Required for Delivery (PSI)	98	89	80	57	
Electric Horsepower Utilized for Delivery (EHP)	69	180	45	231	525
Share of Actual Electricity Cost Allocated to Municipal Customers	4.63%	9.42%	2.37%	12.07%	100.00%

Notes:

⁽¹⁾ Modeled conditions assume that the planned future 24-inch transmission main serving Country Club Hills, Matteson, and Olympia Fields is in place by the year 2030.

⁽²⁾ Orland Park's Allocation of Electricity Costs includes Illinois American-Alpine Heights

⁽³⁾ Tinley Park's Allocation of Electricity Costs includes Illinois American-Arbury and Orland Hills.

⁽⁴⁾ Mokena and New Lenox 2030 Allocations are delivered to Tinley Park Points of Delivery.

Exhibit F
Allocation Rationale and Calculation Methodology
(Electricity Costs)

I. ALLOCATION RATIONALE

- A. All Oak Lawn Regional Water System (System) costs need to be captured and fairly allocated based on benefit received and/or burden placed on the System.
- B. Chicago Water transmission to Municipal Customers with Points of Delivery that are further away and/or at higher elevations than Points of Delivery of other Municipal Customers requires more electrical energy.
- C. Municipal Customers requiring more electrical energy for Chicago Water transmission due to distance and/or elevation should pay a larger share of the cost of electricity to delivery their Chicago Water than Municipal Customers requiring less electrical energy for Chicago Water transmission.
- D. A hydraulic distribution model can be used to estimate the water pressure needed to move water between any two points within a water distribution/transmission system.
- E. For a given flow rate, electrical energy consumed is directly proportional to the pressure needed to move the water between any two points within a water distribution/transmission system.
- F. The flow rates used to allocate electricity costs should be representative of the flow rates used for the design of the System. The 2030 Allocation for each Municipal Customer was used for this purpose.

II. CALCULATION METHODOLOGY

- A. Determine the nominal discharge pressure needed from all pumping stations to deliver the 2030 Allocation to each Municipal Customer's Point of Delivery.
- B. Determine the residual pressure available at each Municipal Customer's Point of Delivery.
- C. Calculate the pressure consumed to get each Municipal Customer's 2030 Allocation to the Municipal Customer's Point of Delivery by subtracting the result of "B" above from the result of "A" above.
- D. Add the minimum pressure required at the Point of Delivery to the result of "C" above. The Illinois Environmental Protection Agency requires all transmission mains to have at least 20 psi of residual pressure so as to prevent ground water infiltration and contamination. The Oak Lawn Retail Water System requires 35 psi of residual pressure to fill its elevated storage tanks.

- E. Use the results of "D" above to calculate the amount of electric horsepower (EHP) required to deliver each Municipal Customer's 2030 Allocation to the Municipal Customer's Point of Delivery as follows:

$$\text{ELECTRIC HORSEPOWER UTILIZED FOR DELIVERY (EHP)} = \frac{\left(\text{2030 ALLOCATION IN CUBIC FEET PER SECOND}^{(1)} \right) \times \left(\text{RESULT "D" ABOVE IN FEET OF WATER}^{(2)} \right) \times \left(\text{UNIT WEIGHT OF WATER IN POUNDS PER CUBIC FOOT}^{(3)} \right)}{\left(550^{(4)} \right) \times \left(\text{WIRE-TO-WATER EFFICIENCY OF PUMPING UNITS}^{(5)} \right)}$$

NOTES:

- ⁽¹⁾ 1 MGD = 1,547 Cubic Foot Per Second
- ⁽²⁾ 1 psi = 2.308 Feet of Water
- ⁽³⁾ Nominal Unit Weight of Water = 62.4 Pounds Per Cubic Foot
- ⁽⁴⁾ Conversion Factor
- ⁽⁵⁾ Nominal Wire-to-Water Efficiency = 0.75 (75%)

- F. Divide the calculated EHP utilized for delivery for each Municipal Customer by the total EHP utilized for delivery by all Municipal Customers and multiply by 100% as follows to determine each Municipal Customer's Share of Actual Electricity Costs:

$$\text{MUNICIPAL CUSTOMER'S SHARE OF ACTUAL ELECTRICITY COSTS} = \frac{\left(\text{EHP UTILIZED FOR DELIVERY BY A GIVEN MUNICIPAL CUSTOMER} \right)}{\left(\text{EHP UTILIZED FOR DELIVERY BY ALL MUNICIPAL CUSTOMERS} \right)} \times (100\%)$$

Exhibit G
Allocation of Pump Station Maintenance Costs

Municipal Customer	Number of Pump Stations Utilized	Share of Actual Pump Station Maintenance Cost Allocated to Municipal Customers
Chicago Ridge	2	8.333%
Palos Hills	2	8.333%
Palos Park	2	8.333%
Oak Forest	2	8.333%
Orland Park ⁽¹⁾	2	8.333%
Tinley Park ⁽²⁾ , Mokena ⁽³⁾ , and New Lenox ⁽³⁾	3	12.500%
Country Club Hills	3	12.500%
Matteson	3	12.500%
Olympia Fields	3	12.500%
Oak Lawn	2	8.333%
Normalization Factor	24	
Totals		100.000%

Notes:

⁽¹⁾Orland Park's Allocation of Pump Station Maintenance Costs includes Illinois American-Alpine Heights

⁽²⁾Tinley Park's Allocation of Pump Station Maintenance Costs includes Illinois American-Arbury and Orland Hills

⁽³⁾Mokena and New Lenox 2030 Allocations are delivered to Tinley Park Points of Delivery.

Exhibit G
Allocation Rationale and Calculation Methodology
(Pump Station Maintenance Costs)

I. ALLOCATION RATIONALE

- A. All Oak Lawn Regional Water System (System) costs need to be captured and fairly allocated based on benefit received and/or burden placed on the System.
- B. Municipal Customers utilizing more pump stations for the conveyance of Chicago Water should pay more for the maintenance of pump stations than those Municipal Customers who utilize less pump stations for the conveyance of Chicago Water.
- C. The total number of pump stations utilized by a given Municipal Customer, compared to the total number of pump stations utilized by other Municipal Customers, can be used to determine the amount of pump station maintenance costs allocated to each Municipal Customer.

II. CALCULATION METHODOLOGY

- A. Determine the number of pump stations utilized by each Municipal Customer. The number for each Municipal Customer is listed on page 1 of this Exhibit G.
- B. Add the total number of pump stations utilized by each Municipal Customer to generate a normalization factor.
- C. Divide the number of pump stations utilized by a given Municipal Customer by the normalization factor.
- D. Multiply the result of "C" above by 100% as follows to determine each Municipal Customer's Share of Actual Pump Station Maintenance Costs:

$$\begin{array}{c}
 \text{MUNICIPAL} \\
 \text{CUSTOMER'S} \\
 \text{SHARE OF} \\
 \text{ACTUAL PUMP} \\
 \text{STATION} \\
 \text{MAINTENANCE} \\
 \text{COSTS}
 \end{array}
 = \frac{\left(\begin{array}{c} \text{NUMBER OF PUMP STATION UNITS} \\ \text{UTILIZED BY A GIVEN MUNICIPAL} \\ \text{CUSTOMER} \end{array} \right)}{\left(\begin{array}{c} \text{NORMALIZATION FACTOR = 24} \end{array} \right)} \times (100\%)$$

Exhibit H
Allocation of Transmission Main Maintenance Costs

Transmission Main Diameter	Municipal Customer	Chicago Ridge ⁽¹⁾	Palos Hills	Palos Park	Oak Forest	Orland Park ⁽²⁾	Tinley Park ⁽³⁾ , Mokena ⁽⁴⁾ , and New Lenox ⁽⁴⁾
	Linear Feet of Transmission Main Utilized by Municipal Customer						
60" diameter	-	-	55,600	55,600	55,600	55,600	55,600
54" diameter	6,500	6,500	6,500	6,500	6,500	6,500	6,500
48" diameter	3,500	32,600	32,600	32,600	32,600	32,600	32,600
42" diameter	12,800	21,300	21,300	21,300	21,300	21,300	26,500
36" diameter	-	27,800	27,800	27,800	27,800	39,200	27,800
30" diameter	9,400	9,400	9,400	9,400	9,400	9,400	9,400
24" diameter	-	3,700	3,700	3,700	3,700	18,400	9,200
20" diameter	-	-	-	-	-	-	-
16" diameter	700	2,300	-	-	2,200	-	-
14" diameter	-	-	-	-	-	-	-
12" diameter	-	-	-	-	-	-	-
10" diameter	-	-	-	2,100	-	-	-
Total Linear Feet of Main Utilized		32,900	159,200	159,000	159,100	183,000	167,600
Percent Utilization of Total Main in the System		13.71%	66.36%	68.28%	66.32%	76.28%	69.86%
Share of Actual Transmission Main Maintenance Cost Allocated to Municipal Customers		2.07%	10.01%	9.99%	10.00%	11.50%	10.53%

Transmission Main Diameter	Municipal Customer	Country Club Hills	Matteson	Olympia Fields	Oak Lawn	Normalization Factor	Total Linear Feet of Transmission Main in the System
	Linear Feet of Transmission Main Utilized by Municipal Customer						
60" diameter	-	55,600	55,600	55,600	55,600	-	55,600
54" diameter	6,500	6,500	6,500	6,500	6,500	-	6,500
48" diameter	32,600	32,600	32,600	32,600	32,600	-	32,600
42" diameter	23,900	23,900	23,900	23,900	21,300	-	26,500
36" diameter	27,800	27,800	27,800	27,800	27,800	-	39,200
30" diameter	9,400	9,400	9,400	9,400	9,400	-	9,400
24" diameter	23,400	34,900	34,900	34,900	3,700	-	50,100
20" diameter	-	-	300	-	-	-	300
16" diameter	1,200	-	-	9,600	-	-	15,900
14" diameter	-	-	-	1,700	-	-	1,700
12" diameter	-	-	-	-	-	-	-
10" diameter	-	-	-	-	-	-	2,100
Total Linear Feet of Main Utilized		180,400	191,000	202,000	158,900		239,900
Percent Utilization of Total Main in the System		75.20%	79.62%	84.20%	65.40%	663.23%	
Share of Actual Transmission Main Maintenance Cost Allocated to Municipal Customers		11.34%	12.00%	12.70%	9.86%		100.00%

Notes:

⁽¹⁾Water transmission to Chicago Ridge from the Oak Lawn Regional Water System is provided in part via Oak Lawn Retail Water System distribution mains. Accordingly, Chicago Ridge's share of actual transmission main maintenance costs shall include the share shown here plus an additional charge for 17% of the Oak Lawn Retail Water System's actual distribution main maintenance cost per Agreement Exhibit A.

⁽²⁾Orland Park's Allocation of Transmission Main Maintenance Costs includes Illinois American-Alpine Heights.

⁽³⁾Tinley Park's Allocation of Transmission Main Maintenance Costs includes Illinois American-Arbury and Orland Hills.

⁽⁴⁾Mokena and New Lenox 2030 Allocations are delivered to Tinley Park Points of Delivery.



This exhibit is dated 2/28/2014 - Final (revised)

H-1



Exhibit H
Allocation Rationale and Calculation Methodology
(Transmission Main Maintenance Costs)

I. ALLOCATION RATIONALE

- A. All Oak Lawn Regional Water System (System) costs need to be captured and fairly allocated based on benefit received and/or burden placed on the System.
- B. Municipal Customers utilizing more transmission main for the conveyance of Chicago Water should pay more for the maintenance of such transmission main than those Municipal Customers who utilize less transmission main for the conveyance of Chicago Water.
- C. The linear footage of transmission main utilized by a given Municipal Customer, compared to the total linear footage of all transmission main in the System, can be used to determine the amount of transmission main maintenance costs allocated to each Municipal Customer.

II. CALCULATION METHODOLOGY

- A. Determine the total linear footage of transmission main that is utilized by each Municipal Customer.
- B. Determine the total linear footage of transmission main in the System by diameter.
- C. Divide the total linear footage of transmission main utilized by each Municipal Customer by the total linear footage of transmission main in the System.
- D. Multiply the result of "C" above by 100% as follows to determine each Municipal Customer's use of total transmission main in the System:

$$\begin{array}{l}
 \text{PERCENT} \\
 \text{UTILIZATION OF} \\
 \text{TRANSMISSION} \\
 \text{MAIN IN THE} \\
 \text{SYSTEM BY A} \\
 \text{GIVEN} \\
 \text{MUNICIPAL} \\
 \text{CUSTOMER}
 \end{array}
 \times
 \frac{
 \left[\begin{array}{c}
 \text{LINEAR FOOTAGE OF TRANSMISSION} \\
 \text{MAIN UTILIZED BY A GIVEN MUNICIPAL} \\
 \text{CUSTOMER}
 \end{array} \right]
 }{
 \left[\begin{array}{c}
 \text{TOTAL LINEAR FOOTAGE OF} \\
 \text{TRANSMISSION MAIN IN THE SYSTEM}
 \end{array} \right]
 }
 \times (100\%)$$

- E. Add the percent utilization of transmission main in the System for each Municipal Customer together to generate a normalization factor.
- F. Divide the percent utilization of transmission main in the System for each Municipal Customer by the normalization factor and multiply the result by 100% as follows to determine each **Municipal Customer's Share of Actual Transmission Main Maintenance Costs**:

$$\begin{array}{l} \text{MUNICIPAL} \\ \text{CUSTOMER'S} \\ \text{SHARE OF} \\ \text{ACTUAL} \\ \text{TRANSMISSION} \\ \text{MAIN} \\ \text{MAINTENANCE} \\ \text{COSTS} \end{array} \times \frac{\left(\begin{array}{c} \text{PERCENT UTILIZATION OF TRANSMISSION} \\ \text{MAIN IN THE SYSTEM BY A GIVEN} \\ \text{MUNICIPAL CUSTOMER} \end{array} \right)}{\left(\begin{array}{c} \text{NORMALIZATION FACTOR} = 506.00\% \end{array} \right)} \times (100\%)$$

Exhibit I
Required Municipal Customer Improvements

The following Water System improvements are to be made by the identified Municipal Customer within one year after the Effective Date of the Water Sale, Purchase and Service Agreement:

1. **Orland Park – Remove the direct connection between the discharge header of the pumping units located at the Orland Park Pumping and Storage Complex and the 36-inch Chicago Water supply line from Oak Lawn just downstream of the Point of Delivery and immediately upstream of the weir structure air gap.**
2. **Palos Hills – Construct an approved backflow prevention device immediately downstream of the Point of Delivery.**

Additionally, Tinley Park shall, within one year after the Effective Date of the Water Sale, Purchase and Service Agreement, investigate and raise (as necessary) the fill line serving the five (5) million gallon CBI (steel) ground storage reservoir at the Tinley Park Storage and Pumping Complex such that the air gap requirements of Agreement Section 14 are satisfied.

EXHIBIT J

CONTRACTS THAT MUNICIPAL CUSTOMERS HAVE WITH OTHERS TO SUPPLY WATER

Supplier	Purchaser	Contract Term
Tinley Park	Illinois American Water Company	at will/ month to month
Orland Park	Illinois American Water Company	at will/ month to month

Note: As is stated in the body of the Agreement, Mokena and New Lenox are served by Tinley Park from the Points of Delivery by Oak Lawn to Tinley Park.

EXHIBIT K

PAYMENTS DUE TO OAK LAWN FOR "OLD BONDS" AND OLD BONDS SPECIAL CONNECTION FEE

I. OLD BONDS FOR 2001 AND 2006 IMPROVEMENTS.

A. *2001 Improvements.* In 2001, Oak Lawn designed and constructed a new fifty-four (54) inch diameter dedicated water transmission main from the City of Chicago's Durkin Park Pumping Station at 85th Street and Keeler Avenue to Oak Lawn's Reich Pumping Station at 91st Street and Southwest Highway (the "*2001 Improvements*"). To pay for the 2001 Improvements, Oak Lawn issued the General Obligation Corporate Purpose Bonds, Series 2001A ("*2001A Bonds*"). The 2001A Bonds have subsequently been refinanced by Oak Lawn through the issuance of its General Obligation Refunding Bonds, Series 2011A ("*2011A Bonds*"). The Southwest System Customers have agreed to pay shares of the debt service for the costs of the 2001 Improvements.

B. *2006 Improvements.* In 2006, Oak Lawn designed and constructed the Harker Pump Station Piping Improvements and the Booster Pump Station Improvements (collectively, "*2006 Improvements*"). To pay for the 2006 Improvements, Oak Lawn issued the General Obligation Corporate Purpose Bonds, Series 2006 ("*2006 Bonds*") and the Southwest System Customers have agreed to pay shares of the debt service for the costs of the 2006 Improvements.

C. *Prior Agreements.* Oak Lawn and the Southwest System Customers have previously entered into certain intergovernmental agreements for the payment of shares of the debt service on the 2001A Bonds and the 2006 Bonds, which the Parties agree will be replaced in full by the terms of this Exhibit K and the Agreement to which it is attached, as more particularly itemized in Exhibit N to the Agreement. In this Exhibit K, the Parties have agreed to conform the method of determining the relative shares of the Customers for both the 2001 and 2006 Improvements to be based on each Customer's current year IDNR Lake Michigan water allocation.

D. *Old Bonds.* The 2001A Bonds, the 2011A Bonds and the 2006 Bonds are collectively referred to as the "*Old Bonds.*"

II. PAYMENTS BY SOUTHWEST SYSTEM CUSTOMERS.

A. *Obligation to Pay.* In addition to the other amounts due pursuant to Section 15 of the Agreement, the Parties recognize and agree that the Southwest System Customers and any other Old Bonds Participating Customers (as hereinafter defined) shall be solely responsible for the payment of all principal and interest costs, on a proportionate basis as described in this Exhibit K, associated with the 2001A Bonds/2011A Bonds issued for the 2001 Improvements and the 2006 Bonds issued for the 2006 Improvements and, in no event shall Oak Lawn be

responsible for any payments from its corporate or other funds for bond principal or interest repayment with respect to the 2001 and 2006 Improvements.

B. *Old Bonds Proportionate Share.* Each Southwest System Customer shall pay its proportionate share of the annual debt service incurred by Oak Lawn related to the 2001 Improvements and the 2006 Improvements, including, but not limited to, all financing, construction and land acquisition costs (if any) and all engineering and legal fees associated therewith. Each Southwest System Customer's share for each of the 2001 Improvements and 2006 Improvements is to be determined based upon that Customer's current annual Lake Michigan water allocation from the IDNR in relation to the current annual water allocations of all other Municipal Customers utilizing the 2001 Improvements and/or 2006 Improvements who have agreed to pay for a share of either or both Improvements, as applicable (hereinafter referred to as its "*Old Bonds Proportionate Share*").

C. *Billing.* Oak Lawn shall invoice each Southwest System Customer for its Old Bonds Proportionate Share of any such debt service payments no less than thirty (30) days prior to Oak Lawn's due date for depositing funds for making any such debt service payments. Each Southwest System Customer shall remit its payment for its Old Bonds Proportionate Share of such debt service payment on or before said due date, so that Oak Lawn has sufficient funds on hand to make the required debt service payment. Each Southwest System Customer's total annual payment for its Old Bonds Proportionate Share of debt service may be divided into two (2) or more partial payments by Oak Lawn so as to follow the payment schedule for Oak Lawn's debt service payments.

D. *Advance Payment.* Any Southwest System Customer may prepay all or any portion of its indebtedness under this Exhibit K without penalty at any time. Any such full debt service prepayment would fulfill all of such Customer's obligations under this Exhibit K.

E. *Duration of Obligation to Pay.* It is anticipated by Oak Lawn and the Southwest System Customers that Oak Lawn will be financing the 2001 and 2006 Improvements by issuing debt instruments with a repayment schedule that does not exceed thirty (30) years for each group of Improvements. As such, each Southwest System Customer agrees that it shall remain obligated under this Exhibit K for the payment of its Old Bonds Proportionate Share for the entire term of the debt instruments issued by Oak Lawn to finance each of the 2001 and 2006 Improvements. Said payment obligation of each Southwest System Customer shall remain in full force and effect even if that Customer ceases to obtain Chicago Water through the Oak Lawn Regional Water System prior to the final payment for the debt service for each of the 2001 and 2006 Improvements by Oak Lawn. In the event that a Southwest System Customer ceases to obtain Chicago Water through the Oak Lawn Regional Water System prior to the final payment for the debt service for each of the 2001 and 2006 Improvements by Oak Lawn, that Customer's Old Bonds Proportionate Share of said annual debt service shall, after that Customer ceases to obtain Chicago Water through the Oak Lawn Regional Water System, be calculated based on that Customer's water allocation during the twelve (12) months immediately preceding the cessation of that Customer's receipt of Chicago Water through the Oak Lawn Regional Water System.

III. REALLOCATION OF OLD BONDS PROPORTIONATE SHARES; OLD BONDS SPECIAL CONNECTION FEE.

A. *Reallocation with Southeast System Customers.* In the event that any existing Southeast System Customer of the Oak Lawn Regional Water System enters into a new water sale, purchase or service agreement with Oak Lawn relative to utilizing the 2001 Improvements, the 2006 Improvements, or both, such agreement shall contain the same terms as provided in this Exhibit K and provisions of the Agreement related to Exhibit K, and each Southwest System Customer's Old Bonds Proportionate Share payments thereafter shall be reduced accordingly (pro rata based upon each Southwest System Customer's current daily water allocation and the combined current daily water allocations of all Oak Lawn Municipal Customers participating in paying the debt service for each of the 2001 Improvements and the 2006 Improvements, including the existing Southeast System Customer).

B. *Reallocation with Future Water Customers.* In the event that Oak Lawn enters into an agreement for water sale, purchase or service with any Future Water Customer other than an Oak Lawn Reserved Share Customer after the Effective Date of this Agreement, Oak Lawn agrees that any such agreement with any such Future Water Customer that utilizes either the 2001 Improvements, the 2006 Improvements, or both, shall require the Future Water Customer to pay its Old Bonds Proportionate Share (based upon the Future Water Customer's then current daily water allocation) of the debt service incurred by Oak Lawn for 2001 Improvements, 2006 Improvements, or both, as utilized by the Future Water Customer, and that future payments of the Old Bonds Proportionate Share owed by each Southwest System Customer shall be reduced accordingly (pro rata based upon its current daily water allocation and the combined current daily water allocations of all Oak Lawn Municipal Customers participating in paying the debt service for each of the 2001 Improvements and the 2006 Improvements, including the Future Water Customer).

C. *Calculation of Old Bonds Special Connection Fee.* The Old Bonds Special Connection Fee shall be calculated as follows: the Buy In Base for Old Bonds multiplied by a fraction, the numerator of which is the annual allocation of Chicago Water by IDNR to the proposed Southeast System Customer or other Future Water Customer as of the Connection Fee Date, and the denominator of which is the sum of the total annual allocations by IDNR to those Municipal Customers as of the Connection Fee Date who are obligated to pay on each series of the Old Bonds pursuant to this Exhibit for the 2001 Improvements, the 2006 Improvements, or both, as are to be utilized by the proposed Customer (collectively, "*Old Bonds Participating Customers*"), plus the amount contained in the numerator for the Chicago Water allocation to the proposed Customer. This formula is further expressed as follows and shall be applied to each series of the Old Bonds:

IDNR water allocation to the proposed Southeast System Customer or Future Water Customer as of the Connection Fee Date <hr/> IDNR annual water allocations to the Old Bonds Participating Customers as of the Connection Fee Date plus the amount included in the numerator	X	Buy In Base for Old Bonds	=	Old Bonds Special Connection Fee
--	---	---------------------------	---	----------------------------------

Such Old Bonds Special Connection Fee shall be paid to all Old Bonds Participating Customers on a proportionate basis based upon the following formula:

Old Bonds Special Connection Fee	X	Old Bonds Participating Customer's Chicago Water annual allocation from IDNR as of the Connection Fee Date <hr/> The total Chicago Water annual allocation of all Old Bonds Participating Customers as of the Connection Fee Date	=	Old Bonds Participating Customer's share of the Special Connection Fee
----------------------------------	---	--	---	--

IV. INDEMNIFICATION.

For and in consideration of the obligations assumed by Oak Lawn under this Exhibit K and related provisions of the Agreement pertaining to the Old Bonds, each Southwest System Customer shall release, defend, indemnify and hold Oak Lawn, its officers, agents and employees (the "Oak Lawn Indemnified Parties") harmless from any and all claims, demands, lawsuits, damages, judgments or costs, including reasonable attorney's fees (collectively referred to as "Claims") of whatsoever nature occurring, arising from or related to any challenge to the legality of this Exhibit K and related provisions of the Agreement pertaining to the Old Bonds, by an individual and/or entity not a party to the Agreement. However, in the event Oak Lawn exercises this indemnification provision, each Southwest System Customer shall retain the right to appoint counsel of its choosing to defend against any such challenge and shall retain the right to settle or compromise any such claim with or without the consent of Oak Lawn. In addition, this indemnification obligation shall be borne by all the Participating Municipalities in their applicable Old Bonds Proportionate Shares. Without limiting the generality of the foregoing indemnity, and by way of example only, each Southwest System Customer shall release, defend, indemnify and hold the Oak Lawn Indemnified Parties harmless from any Claims by Municipal Customers or Future Water Customers with respect to their ability to utilize the 2001 or 2006 Improvements as a consequence of this Exhibit K or any payments associated therewith which may be required under this Exhibit K and the Agreement. In addition, each Southwest System Customer shall remain legally responsible for the payment of its Old Bonds Proportionate Share of the bond and interest payment irrespective of any Claims or the outcome of any legal proceedings regarding such Claims.

Exhibit L
Determinations of Available Capacity

PART I. SHORT-TERM / YEAR-TO-YEAR AVAILABLE CAPACITY DETERMINATION AND CALCULATION METHODOLOGY

- A. This Part I shall be used to determine the meaning of "Available Capacity" in Section 1 of the Agreement for the purpose of Section 6.C of the Agreement. Pursuant to Section 6.C of the Agreement, Municipal Customers may request, and should have access to, Available Capacity for periods of up to one year, on a year-to-year basis, throughout the term of the Agreement.
- B. Available Capacity can be determined on a year-to-year basis using the following information about the Oak Lawn Regional Water System (System): 1) System design capacity data, 2) prior year maximum daily System demand data, 3) System projected use data, and 4) data showing prior year use of Available Capacity.
- C. Each requesting Municipal Customer may receive a proportionate amount of Available Capacity based on the ratio of its 2030 Allocation to all Municipal Customer 2030 Allocations. The calculation methodology for these determinations are set forth in paragraph 1.D through 1.H below.
- D. At the beginning of each new calendar year, determine the prior year's recorded maximum daily System demand in million gallons per day (MGD).
- E. Adjust the result of "D" above to account for actual use of Available Capacity by one or more Municipal Customers in the prior year by subtracting the use of such Available Capacity from the recorded maximum daily System demand. The subtraction is necessary to reflect the fact that such Available Capacity is not guaranteed, but is accommodated, on a year-to-year, as available, basis.
- F. Adjust the result of "E" above to account for projected given year increases (or decreases) in System-wide Chicago Water use by multiplying the prior year's recorded maximum daily System demand by an appropriate increase (or decrease) factor (e.g., 1.02 for a 2% projected increase in Chicago Water use, or 0.98 for a 2% projected decrease in Chicago Water use).
- G. Subtract the result of "F" above from the System design capacity to determine the Available Capacity in the System. The Total Regional System Design Capacity is 111 million gallons per day (MGD) as shown in Exhibit D. Approximately 18 MGD of this design capacity is available to the Oak Lawn Retail Water System and Chicago Ridge via the System's northern pressure zone and approximately 93 MGD of this design capacity is available to the remaining Municipal Customers served by the System's southern pressure zone.

H. Determine the Available Capacity that a Given Municipal Customer in a Given Year Can Access by multiplying the result of "G" above by the ratio of a given Municipal Customer's 2030 Allocation to the total of all Municipal Customer 2030 Allocations for the pressure zone involved, as follows:

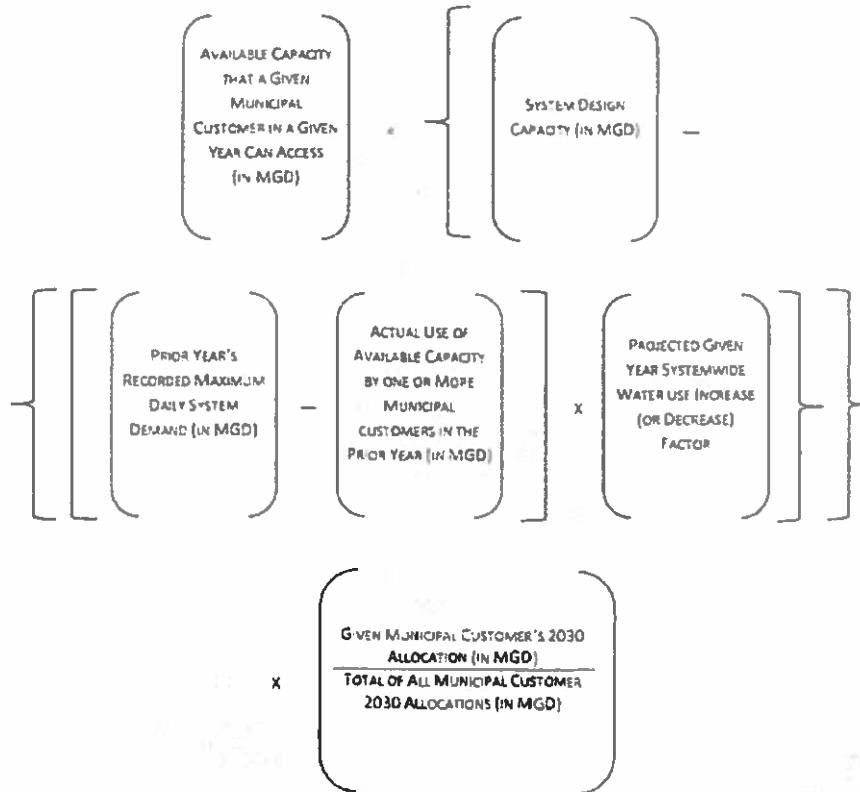

Example calculation for illustration only—Hypothetical situation in 2019 to determine whether there is Available Capacity for use by Orland Park:

1. System Design Capacity (Southern Pressure Zone) = 93 mgd
2. 2018 recorded maximum daily system demand for southern pressure zone Municipal Customers = 73.685 mgd
3. Available Capacity Used by Orland Park and Oak Forest in 2018 (based on Available Capacity allocated in prior year) = 2.015 mgd
4. Excess flow that exceeded 2.0 peaking factor (i.e., a Municipal Customer without any prior allocation of available capacity) = 0.9 mgd (Tinley Park)
5. Projected Regional Water System-wide water use increase = 1.4%
6. Orland Park's 2030 IDNR flow allocation = 10.335 mgd

7. Total of Municipal Customers 2030 Allocations on southern pressure zone = 41.543 mgd
- Available Capacity in 2019 for all southern pressure zone Municipal Customers = $\{(93 \text{ mgd}) - \{((73.685 \text{ mgd}) - (2.015 \text{ mgd}) - (0.9 \text{ mgd})) \times (1.014)\}\} = 21.2 \text{ mgd}$
 - Available Capacity that can be allocated to Orland Park in 2019 = $(21.2 \text{ mgd}) \times (10.335 \text{ mgd}/41.543 \text{ mgd}) = 5.28 \text{ MGD}$

PART II. LONG-TERM AVAILABLE CAPACITY DETERMINATION FOR FUTURE WATER CUSTOMERS

- A. This Part II shall be used to determine the meaning of "Available Capacity" in Section 1 of the Agreement for the purposes of Section 21.A(1) of the Agreement. Pursuant to Section 21.A of the Agreement, prior to entering into an agreement for the purchase, sale, hypothecation or conveyance of Chicago Water to a Future Water Customer, Oak Lawn shall first provide notice to Municipal Customers that there is Available Capacity for the Chicago Water covered by such an agreement.
- B. The Available Capacity of the System to support the long-term water demands of a proposed Future Water Customer shall be determined by a qualified independent consulting engineer as described in the definition of Available Capacity in Section 1 of the Agreement. Such determination shall consider the following factors, as a minimum:
1. The Total Regional System Design Capacity, as shown in Exhibit D, and as further defined within this Exhibit, and the available supply of Chicago Water.
 2. The desired Chicago Water demands of the proposed Future Water Customer.
 3. The contractual water supply obligations that Oak Lawn has with then current Municipal Customers, including, without limitation, those agreements listed in the definition of Available Capacity in Section 1 of the Agreement.
 4. The then current delivery capacity of the System and pressure zone, taking into account any degradation in Total Regional System Design Capacity, any limitation in the ability of the City of Chicago to deliver Chicago Water to Oak Lawn, and any changes in the Chicago-Oak Lawn Agreement.
 5. Any regulatory impacts on the System.
 6. Any capital and operating deficiencies in the System and any corrective measures and associated costs for any required improvements, including the costs associated with serving the proposed Future Water Customer.

- C. If the independent consulting engineer determines, based upon review of all of the factors in this Part II, that the proposed water demands of the Future Water Customer can be met, then the independent consulting engineer shall provide a written attestation to that effect, in the form of a report of findings, signed and sealed by a Licensed Professional Engineer in the State of Illinois. The costs of such a report shall be considered a System Operations Cost.



Exhibit M: Sample Special Connection Fee Calculation

November 12, 2013

Assumptions

- Water Agreement signed Fall 2013 by Southwest System Customers and signed by North System Customers prior to the Effective Date
- Debt service structured to maximize use of IEPA loans for 2013 Regional Water System Improvement capital costs
- Olympia Fields and Country Club Hills join Regional Water System on January 1, 2016
- Matteson joins Regional Water System on January 1, 2020
- Additional New Customer joins Regional Water System on January 1, 2022
 - New Customer Proportionate Share of 10.00%, using 4.50 MGD
- Weighted Average interest rates of all bonds issued at 2.50%
- Analysis compares 2023 debt costs, special connection fees paid by new customers and fees received by existing customers

Buy In Base/Special Connection Fee

- Buy in Base is dependent on future value of capital costs and charges, which are expected to begin in 2016. The following is the future value of debt service in the assumed connection year
 - 2016 - \$0
 - 2020 - \$22,894,557
 - 2022 - \$44,637,213
- Future Customer Special Connection Fee is based on the Buy In Base and the proportionate share of the new customer
 - Olympia Fields - \$0 (2016)
 - Country Club Hills - \$0 (2016)
 - Matteson - \$1,941,662 (2020)
 - New Customer - \$4,463,721 (2022)

Participating Customers Share of Special Connection Fee

	2016 (Addition of Olympia Fields & Country Club Hills)	2020 (Addition of Matteson)	2022 (Addition of New Customer)
New Customer	N/A	N/A	\$0
Chicago Ridge	0	12,297	25,732
Palos Hills	0	102,547	214,437
Palos Park	0	40,425	84,540
Oak Forest	0	141,259	295,402
Orland Park	0	481,333	1,006,522
Country Club Hills	0	73,460	168,879
Matteson	N/A	0	378,563
Olympia Fields	0	46,440	106,761
Oak Lawn	0	213,219	445,862
Tinley Park (ALL)	0	830,681	1,737,022
Tinley Park (ONLY)	0	435,826	911,373
Mokena	0	145,650	304,543
New Lenox	0	249,206	521,107

Proportionate Shares

	Base Case (Partial Participation)	2016 (Addition of Olympia Fields & Country Club Hills)	2020 (Addition of Matteson)	2022 (Addition of New Customer)
New Customer*	N/A	N/A	N/A	10.000%
Chicago Ridge	0.675%	0.633%	0.576%	0.518%
Palos Hills	5.629%	5.281%	4.804%	4.324%
Palos Park	2.219%	2.082%	1.894%	1.705%
Oak Forest	7.754%	7.275%	6.618%	5.956%
Orland Park	26.421%	24.790%	22.549%	20.294%
Country Club Hills	N/A	3.783%	3.783%	3.405%
Matteson	N/A	N/A	8.481%	7.633%
Olympia Fields	0.00%	2.392%	2.392%	2.153%
Oak Lawn	11.704%	10.981%	9.989%	8.990%
Tinley Park (ALL)	45.598%	42.782%	38.914%	35.023%
Tinley Park (ONLY)	23.923%	22.446%	20.417%	18.375%
Mokena	7.995%	7.501%	6.823%	6.141%
New Lenox	13.679%	12.835%	11.674%	10.507%

* Proportional Share for New Customer is assumed at 10.00% for analytical purposes and does not reflect an engineering analysis for a specific customer.

2023 Annual Capital Costs

	Base Case	Addition of Olympia Fields & Country Club Hills	Addition of Matteson	Addition of New Customer
New Customer	N/A	N/A	N/A	\$1,082,519
Chicago Ridge	\$73,070	\$68,558	\$62,405	56,118
Palos Hills	609,350	571,722	520,042	468,038
Palos Park	240,211	225,378	205,022	184,526
Oak Forest	839,385	787,552	716,394	644,770
Orland Park	2,860,157	2,683,539	2,440,966	2,196,876
Country Club Hills	N/A	409,556	409,556	368,565
Matteson	N/A	N/A	918,072	826,276
Olympia Fields	N/A	258,912	258,912	233,045
Oak Lawn	1,223,226	1,144,989	1,037,529	929,442
Tinley Park (ALL)	4,936,039	4,631,223	4,212,540	3,791,624
Tinley Park (ONLY)	2,589,743	2,429,824	2,210,215	1,989,162
Mokena	865,474	812,030	738,562	664,743
New Lenox	1,480,821	1,389,379	1,236,762	1,137,360



Supporting Information

**Exhibit E
Proportionate Shares**

Municipal Customer	Share of Actual 2012 Regional System Improvement Costs Allocated to Municipal Customers	Share of Actual 2012 Regional System Improvement Costs Allocated to Municipal Customers Without Southeast System Municipal Customer Participation	Share of Actual Southeast System Improvement Costs Allocated to Municipal Customers
Chicago Ridge	0.576%	0.675%	0.000%
Palos Hills	4.804%	5.629%	0.000%
Palos Park	1.894%	2.219%	0.000%
Oak Forest	6.618%	7.754%	0.000%
Orland Park	22.549%	26.421%	0.000%
Tinley Park (ALL)	38.914%	45.598%	0.000%
Country Club Hills	3.783%	0.000%	25.810%
Matteson	8.481%	0.000%	57.870%
Olympia Fields	2.392%	0.000%	16.320%
Oak Lawn	9.989%	11.704%	0.000%
Tinley Park (ONLY)	20.417%	23.923%	0.000%
Mokena	6.823%	7.895%	0.000%
New Lenox	11.674%	13.679%	0.000%
Orland Hills	0.000%	0.000%	0.000%
Totals	100.000%	100.000%	100.000%

VILLAGE OF OAK LAWN, ILLINOIS
REGIONAL WATER SYSTEM
 Future Users Special Connection Fee

Summary of Scenarios

Buy-In Year (January 1st)	2014	2015	2016	2017	2018	2019	2020	2021	2022	2023
CAPITAL COSTS AND CHARGES										
REVENUE DEBT SERVICE										
Senior Lien Debt Service (System Improv)	0	0	0	0	0	106,958	261,500	261,500	261,500	261,500
2nd Lien Debt Service	0	0	0	0	0	0	0	0	0	0
EPA Debt Service	0	0	0	1,168,502	2,574,875	7,682,873	10,499,939	10,499,939	10,499,939	10,499,939
Total Revenue Debt Service	0	0	0	1,168,502	2,574,875	7,791,831	10,761,439	10,761,439	10,761,439	10,761,439
RESERVES										
EPA Reserve	0	0	0	0	0	0	0	0.00	0.00	0.00
Total Reserves	0	0	0	0	0	0	0	0.00	0.00	0.00
TOTAL Capital Costs and Charges	0	0	0	1,168,502	2,574,875	7,791,831	10,761,439	10,761,439	10,761,439	10,761,439
Special Connection Fee Calculation										
Future Value Factor (bond rate)	2.50%	2.50%	2.50%	2.50%	2.50%	2.50%	2.50%	2.50%	2.50%	2.50%
Actual - Buy In Base	0	0	0	1,168,502	3,743,478	11,535,309	22,296,748	33,058,187	43,819,626	54,581,065
Future Value - Buy In Base	0	0	0	1,168,502	3,864,783	12,027,233	22,894,557	33,764,528	44,637,213	55,512,678
Future Customer Special Connection Fee										
Country Club Hills	0	0	0	44,209	146,219	455,034	866,184	1,277,435	1,688,788	1,890,040
Matteson	0	0	0	99,098	327,708	1,020,048	1,941,862	2,863,532	3,785,622	4,237,227
Olympia Fields	0	0	0	27,948	92,436	287,862	547,682	807,595	1,067,613	1,195,077
New Customer	0	0	0	116,850	386,478	1,202,723	2,289,456	3,376,453	4,463,721	5,551,268
	0	0	0	288,106	952,901	2,965,435	5,644,883	8,324,884	11,005,753	12,873,612
Participating Customer's Share of Special Connection Fee										
New Customer	0	0	0	0	0	0	0	0	0	1,482,971
Chicago Ridge	0	0	0	1,825	6,035	18,781	35,750	47,992	63,446	88,737
Country Club Hills	0	0	0	10,900	36,052	112,193	213,568	314,964	416,398	438,308
Matteson	0	0	0	0	0	0	0	706,033	933,386	982,630
Oak Forest	0	0	0	20,850	69,325	215,741	419,875	530,935	726,344	766,718
Oak Lawn	0	0	0	31,638	104,841	325,642	619,480	831,548	1,099,319	1,157,351
Olympia Fields	0	0	0	6,891	22,791	70,928	135,012	199,113	263,211	277,143
Orland Park	0	0	0	71,421	236,222	735,124	1,399,353	1,877,195	2,481,681	2,612,584
Palos Hills	0	0	0	15,216	50,327	156,617	298,129	399,932	520,718	556,604
Palos Park	0	0	0	5,998	19,839	61,140	117,525	157,659	208,441	219,444
Truay Park (ALL)	0	0	0	123,257	407,670	1,268,672	2,414,993	3,239,603	4,282,603	4,508,674
Truay Park (Only)	0	0	0	64,668	213,888	665,622	1,267,051	1,699,739	2,247,081	2,365,565
Mokena	0	0	0	23,812	71,480	222,448	423,440	567,982	750,881	790,530
New Lenox	0	0	0	35,977	122,302	380,604	724,503	971,881	1,284,841	1,352,579
	0	0	0	288,106	952,901	2,965,435	5,644,883	8,324,884	11,005,753	11,586,251
Proportionate Share										
New Customer	0.000%	0.000%	0.000%	0.000%	0.000%	0.000%	0.000%	0.000%	0.000%	10.000%
Chicago Ridge	0.675%	0.675%	0.633%	0.833%	0.633%	0.633%	0.576%	0.576%	0.518%	0.518%
Country Club Hills	0.000%	0.000%	3.783%	3.783%	3.783%	3.783%	3.783%	3.783%	3.405%	3.405%
Matteson	0.000%	0.000%	0.000%	0.000%	0.000%	0.000%	8.481%	8.481%	7.633%	7.633%
Oak Forest	7.754%	7.754%	7.275%	7.275%	7.275%	7.275%	6.618%	6.618%	5.956%	5.956%
Oak Lawn	11.704%	11.704%	10.981%	10.981%	10.981%	10.981%	9.989%	9.989%	8.950%	8.950%
Olympia Fields	0.000%	0.000%	2.392%	2.392%	2.392%	2.392%	2.392%	2.392%	2.153%	2.153%
Orland Park	26.421%	26.421%	24.790%	24.790%	24.790%	24.790%	22.549%	22.549%	20.294%	20.294%
Palos Hills	5.629%	5.629%	5.281%	5.281%	5.281%	5.281%	4.804%	4.804%	4.324%	4.324%
Palos Park	2.219%	2.219%	2.082%	2.082%	2.082%	2.082%	1.894%	1.894%	1.705%	1.705%
Truay Park (ALL)	45.598%	45.598%	42.782%	42.782%	42.782%	42.782%	38.914%	38.914%	35.023%	35.023%
Truay Park (Only)	23.923%	23.923%	22.448%	22.448%	22.448%	22.448%	20.417%	20.417%	18.375%	18.375%
Mokena	7.985%	7.985%	7.501%	7.501%	7.501%	7.501%	6.823%	6.823%	6.141%	6.141%
New Lenox	13.679%	13.679%	12.835%	12.835%	12.835%	12.835%	11.674%	11.674%	10.507%	10.507%
Total	100.000%	100.000%	100.000%	100.000%	100.000%	100.000%	100.000%	100.000%	100.000%	100.000%

Buy-In Year (January 1st)	2014	2015	2016	2017	2018	2019	2020	2021	2022	2023
CAPITAL COSTS AND CHARGES										
REVENUE DEBT SERVICE										
Senior Lien Debt Service (System Improv)	0	0	0	0	0	108,958	261,500	261,500	261,500	261,500
2nd Lien Debt Service	0	0	0	0	0	0	0	0	0	0
EPA Debt Service	0	0	0	1,168,502	2,574,975	7,862,873	10,499,939	10,499,939	10,499,939	10,499,939
Total Revenue Debt Service	0	0	0	1,168,502	2,574,975	7,971,831	10,761,438	10,761,438	10,761,438	10,761,438
RESERVES										
EPA Reserve	0	0	0	0	0	0	0	0.00	0.00	0.00
Total Reserves	0	0	0	0	0	0	0	0.00	0.00	0.00
TOTAL Capital Costs and Charges	0	0	0	1,168,502	2,574,975	7,971,831	10,761,438	10,761,438	10,761,438	10,761,438
Special Connection Fee Calculator										
Future Value Factor (bond rate)	2.50%	2.50%	2.50%	2.50%	2.50%	2.50%	2.50%	2.50%	2.50%	2.50%
Actual - Buy In Base	0	0	0	1,168,502	3,743,478	11,535,309	22,298,748	33,058,187	43,818,626	54,581,065
Future Value - Buy In Base	0	0	0	1,168,502	3,664,783	12,027,233	22,894,557	33,764,520	44,637,213	55,512,678
Future Customer Special Connection Fee										
Country Club Hills	0	0	44,209	148,219	455,034	866,184	1,277,435	1,688,788	2,100,040	2,511,292
Matteson	0	0	27,948	92,436	287,682	547,582	807,585	1,067,613	1,327,641	1,587,669
Olympia Fields	0	0	72,156	238,655	742,698	1,413,766	2,084,999	2,756,400	3,427,801	4,099,202
New Customer	0	0	0	0	0	0	0	0	0	0
Participating Customer's Share of Special Connection Fee										
New Customer	0	0	0	0	0	0	0	0	0	355,389
Chicago Ridge	0	0	457	1,511	4,704	8,954	12,820	15,890	19,956	24,022
Country Club Hills	0	0	2,730	9,029	28,099	53,488	78,883	104,285	130,687	157,089
Matteson	0	0	0	0	0	0	0	0	0	0
Oak Forest	0	0	5,250	17,363	54,032	102,854	137,982	182,414	233,767	293,484
Oak Lawn	0	0	7,924	26,207	81,557	155,249	208,282	275,325	353,955	445,755
Olympia Fields	0	0	1,728	5,708	17,783	33,814	49,868	65,922	82,476	100,030
Orland Park	0	0	17,887	59,182	184,112	350,469	470,145	621,539	802,097	1,002,655
Palos Hills	0	0	3,811	12,604	39,225	74,687	100,163	132,417	171,671	218,925
Palos Park	0	0	1,502	4,989	15,463	29,434	39,488	52,204	67,810	86,316
Tinley Park (ALL)	0	0	30,870	102,101	317,740	604,837	811,381	1,072,632	1,399,883	1,794,134
Tinley Park (Only)	0	0	16,188	53,589	166,706	317,334	425,701	562,783	738,900	944,017
Mokena	0	0	5,413	17,902	55,712	108,051	142,252	186,059	241,460	307,461
New Lenox	0	0	9,281	30,631	95,323	181,432	243,408	321,780	417,941	534,102
Total	0	0	72,156	238,655	742,698	1,413,766	2,084,999	2,756,400	3,427,801	4,099,202
Proportional Share										
New Customer	0.000%	0.000%	0.000%	0.000%	0.000%	0.000%	0.000%	0.000%	0.000%	10.000%
Chicago Ridge	0.675%	0.675%	0.633%	0.633%	0.633%	0.633%	0.576%	0.576%	0.518%	0.518%
Country Club Hills	0.000%	0.000%	3.783%	3.783%	3.783%	3.783%	3.783%	3.783%	3.405%	3.405%
Matteson	0.000%	0.000%	0.000%	0.000%	0.000%	0.000%	0.000%	0.000%	7.633%	7.633%
Oak Forest	7.754%	7.754%	7.278%	7.278%	7.278%	7.278%	6.818%	6.818%	5.956%	5.956%
Oak Lawn	11.704%	11.704%	10.981%	10.981%	10.981%	10.981%	9.989%	9.989%	8.990%	8.990%
Olympia Fields	0.000%	0.000%	2.382%	2.382%	2.382%	2.382%	2.382%	2.382%	2.153%	2.153%
Orland Park	26.421%	26.421%	24.790%	24.790%	24.790%	24.790%	22.549%	22.549%	20.294%	20.294%
Palos Hills	5.629%	5.629%	5.281%	5.281%	5.281%	5.281%	4.804%	4.804%	4.324%	4.324%
Palos Park	2.219%	2.219%	2.082%	2.082%	2.082%	2.082%	1.894%	1.894%	1.705%	1.705%
Tinley Park (ALL)	45.598%	45.598%	42.782%	42.782%	42.782%	42.782%	38.914%	38.914%	35.023%	35.023%
Tinley Park (Only)	23.923%	23.923%	22.446%	22.446%	22.446%	22.446%	20.417%	20.417%	18.375%	18.375%
Mokena	7.895%	7.895%	7.501%	7.501%	7.501%	7.501%	6.823%	6.823%	6.141%	6.141%
New Lenox	13.679%	13.679%	12.835%	12.835%	12.835%	12.835%	11.674%	11.674%	10.507%	10.507%
Total	100.000%	100.000%	100.000%	100.000%	100.000%	100.000%	100.000%	100.000%	100.000%	100.000%

VILLAGE OF OAK LAWN, ILLINOIS
REGIONAL WATER SYSTEM
 Future Users Special Connection Fee

2020 Buy In
 Village of Matteson

Buy-In Year (January 1st)	2014	2015	2016	2017	2018	2019	2020	2021	2022	2023
CAPITAL COSTS AND CHARGES										
REVENUE DEBT SERVICE										
Senior Lien Debt Service (System Improv)	0	0	0	0	0	108,958	261,500	261,500	261,500	261,500
2nd Lien Debt Service	0	0	0	0	0	0	0	0	0	0
EPA Debt Service	0	0	0	1,168,502	2,574,975	7,682,873	10,499,939	10,499,939	10,499,939	10,499,939
Total Revenue Debt Service	0	0	0	1,168,502	2,574,975	7,791,831	10,761,438	10,761,438	10,761,438	10,761,438
RESERVES										
EPA Reserve	0	0	0	0	0	0	0	0.00	0.00	0.00
Total Reserves	0	0	0	0	0	0	0	0.00	0.00	0.00
TOTAL Capital Costs and Charges	0	0	0	1,168,502	2,574,975	7,791,831	10,761,438	10,761,438	10,761,438	10,761,438
Special Connection Fee Calculator										
Future Value Factor (bond rate)	2.50%	2.50%	2.50%	2.50%	2.50%	2.50%	2.50%	2.50%	2.50%	2.50%
Actual - Buy In Base	0	0	0	1,168,502	3,743,478	11,535,309	22,286,748	33,058,187	43,819,628	54,581,065
Future Value - Buy In Base	0	0	0	1,168,502	3,864,783	12,027,233	22,894,557	33,784,526	44,831,213	55,512,678
Future Customer Special Connection Fee										
Country Club Hills										
Matteson		0	0	99,099	327,768	1,020,016	1,941,662	2,863,532	3,785,632	4,237,227
Olympia Fields										
New Customer		0	0	99,099	327,768	1,020,016	1,941,662	2,863,532	3,785,632	4,237,227
Proportionate Customer's Share of Special Connection Fee										
New Customer	0.000%	0.000%	0.000%	0.000%	0.000%	0.000%	0.000%	0.000%	10.000%	10.000%
Chicago Ridge	0.675%	0.675%	0.633%	0.633%	0.633%	0.633%	0.576%	0.576%	0.518%	0.518%
Country Club Hills	0.000%	0.000%	3.783%	3.783%	3.783%	3.783%	3.783%	3.783%	3.405%	3.405%
Matteson	0.000%	0.000%	0.000%	0.000%	0.000%	0.000%	8.481%	8.481%	7.633%	7.633%
Oak Forest	7.754%	7.754%	7.275%	7.275%	7.275%	7.275%	6.618%	6.618%	5.956%	5.956%
Oak Lawn	11.704%	11.704%	10.981%	10.981%	10.981%	10.981%	9.989%	9.989%	8.990%	8.990%
Olympia Fields	0.000%	0.000%	2.392%	2.392%	2.392%	2.392%	2.392%	2.392%	2.153%	2.153%
Orland Park	26.421%	26.421%	24.790%	24.790%	24.790%	24.790%	22.549%	22.549%	20.294%	20.294%
Palos Hills	5.629%	5.629%	5.261%	5.261%	5.261%	5.261%	4.804%	4.804%	4.324%	4.324%
Palos Park	2.219%	2.219%	2.082%	2.082%	2.082%	2.082%	1.894%	1.894%	1.705%	1.705%
Triley Park (ALL)	45.598%	45.598%	42.782%	42.782%	42.782%	42.782%	38.914%	38.914%	35.023%	35.023%
Triley Park (Only)	23.923%	23.923%	22.446%	22.446%	22.446%	22.446%	20.417%	20.417%	18.375%	18.375%
Mokena	7.995%	7.995%	7.501%	7.501%	7.501%	7.501%	6.823%	6.823%	6.141%	6.141%
New Lenox	13.679%	13.679%	12.835%	12.835%	12.835%	12.835%	11.674%	11.674%	10.507%	10.507%
Total	100.000%	100.000%	100.000%	100.000%	100.000%	100.000%	100.000%	100.000%	100.000%	100.000%

VILLAGE OF OAK LAWN, ILLINOIS
REGIONAL WATER SYSTEM
Future Users Special Connection Fee

2022 Buy In
New Customer

Buy-in Year (January 1st)	2014	2015	2016	2017	2018	2019	2020	2021	2022	2023
CAPITAL COSTS AND CHARGES										
REVENUE DEBT SERVICE										
Senior Lien Debt Service (System Improv)	0	0	0	0	0	108,958	261,500	261,500	261,500	261,500
2nd Lien Debt Service	0	0	0	0	0	0	0	0	0	0
EPA Debt Service	0	0	0	1,168,502	2,574,975	7,682,873	10,489,839	10,489,939	10,489,939	10,489,839
Total Revenue Debt Service	0	0	0	1,168,502	2,574,975	7,791,831	10,751,438	10,751,439	10,751,438	10,751,438
RESERVES										
EPA Reserve	0	0	0	0	0	0	0	0.00	0.00	0.00
Total Reserves	0	0	0	0	0	0	0	0.00	0.00	0.00
TOTAL Capital Costs and Charges	0	0	0	1,168,502	2,574,975	7,791,831	10,751,438	10,751,439	10,751,438	10,751,438
Special Connection Fee Calculation										
Future Value Factor (bond rate)	2.50%	2.50%	2.50%	2.50%	2.50%	2.50%	2.50%	2.50%	2.50%	2.50%
Actual - Buy In Base	0	0	0	1,168,502	3,743,478	11,535,309	22,298,748	33,058,187	43,819,626	54,581,065
Future Value - Buy In Base	0	0	0	1,168,502	3,864,783	12,027,233	22,864,557	33,764,528	44,637,213	55,512,678
Future Customer Special Connection Fee										
Country Club Hills										
Maitland										
Olympia Fields										
New Customer	0	0	0	116,850	366,478	1,202,723	2,289,456	3,376,453	4,463,721	5,551,259
	0	0	0	116,850	366,478	1,202,723	2,289,456	3,376,453	4,463,721	5,551,259
Participant Customer's Share of Special Connection Fee										
New Customer	0	0	0	0	0	0	0	0	0	639,478
Chicago Ridge	0	0	740	2,448	7,617	14,500	19,465	25,732	28,778	28,778
Country Club Hills	0	0	4,421	14,622	45,503	86,618	127,743	168,879	189,004	189,004
Maitland	0	0	0	0	0	0	286,353	378,563	423,723	423,723
Oak Forest	0	0	8,501	28,117	87,500	168,562	223,448	295,402	330,645	330,645
Oak Lawn	0	0	12,832	42,440	132,074	251,411	337,280	445,982	499,065	499,065
Olympia Fields	0	0	2,795	9,244	28,768	54,758	80,750	106,761	119,508	119,508
Orland Park	0	0	28,987	95,807	298,152	567,550	761,354	1,005,522	1,126,580	1,126,580
Palos Hills	0	0	8,171	26,411	83,521	120,915	162,205	214,437	240,015	240,015
Palos Park	0	0	2,433	8,046	25,040	47,866	63,948	84,540	94,627	94,627
Tinley Park (ALL)	0	0	49,891	165,343	514,549	979,475	1,313,920	1,737,022	1,944,198	1,944,198
Tinley Park (Only)	0	0	26,228	86,748	269,963	513,891	689,382	911,373	1,020,062	1,020,062
Mokena	0	0	8,765	28,991	90,220	171,739	230,363	304,543	340,887	340,887
New Lenox	0	0	14,997	49,803	154,386	293,844	394,116	521,107	583,250	583,250
	0	0	116,850	366,478	1,202,723	2,289,456	3,376,453	4,463,721	4,463,721	4,998,141
Proportional Share										
New Customer	0.000%	0.000%	0.000%	0.000%	0.000%	0.000%	0.000%	0.000%	10.000%	10.000%
Chicago Ridge	0.675%	0.675%	0.633%	0.633%	0.633%	0.633%	0.576%	0.576%	0.518%	0.518%
Country Club Hills	0.000%	0.000%	3.783%	3.783%	3.783%	3.783%	3.783%	3.783%	3.405%	3.405%
Maitland	0.000%	0.000%	0.000%	0.000%	0.000%	0.000%	8.481%	8.481%	7.633%	7.633%
Oak Forest	7.754%	7.754%	7.275%	7.275%	7.275%	7.275%	6.618%	6.618%	5.956%	5.956%
Oak Lawn	11.704%	11.704%	10.981%	10.981%	10.981%	10.981%	9.989%	9.989%	8.990%	8.990%
Olympia Fields	0.000%	0.000%	2.382%	2.382%	2.382%	2.382%	2.382%	2.382%	2.153%	2.153%
Orland Park	26.421%	26.421%	24.790%	24.790%	24.790%	24.790%	22.549%	22.549%	20.294%	20.294%
Palos Hills	5.629%	5.629%	5.281%	5.281%	5.281%	5.281%	4.804%	4.804%	4.324%	4.324%
Palos Park	2.219%	2.219%	2.082%	2.082%	2.082%	2.082%	1.894%	1.894%	1.705%	1.705%
Tinley Park (ALL)	45.598%	45.598%	42.782%	42.782%	42.782%	42.782%	38.914%	38.914%	35.023%	35.023%
Tinley Park (Only)	23.923%	23.923%	22.446%	22.446%	22.446%	22.446%	20.417%	20.417%	18.375%	18.375%
Mokena	7.895%	7.895%	7.501%	7.501%	7.501%	7.501%	6.823%	6.823%	6.141%	6.141%
New Lenox	13.679%	13.679%	12.835%	12.835%	12.835%	12.835%	11.674%	11.674%	10.507%	10.507%
Total	100.000%	100.000%	100.000%	100.000%	100.000%	100.000%	100.000%	100.000%	100.000%	100.000%

EXHIBIT N

SUPERSEDED INTERGOVERNMENTAL AGREEMENTS

AGREEMENT	DATE
PRIMARY WATER CONTRACTS	
Water Supply Contract Between Village of Oak Lawn and Village of Tinley Park	April 4, 1973
Amendment to Water Supply Contract Between Village of Oak Lawn and Village of Tinley Park	April 22, 1986
Second Amendment to Water Supply Contract Between Village of Oak Lawn and Village of Tinley Park	February 20, 2001
Term Extension Amendment to Water Supply Contract Between Village of Oak Lawn and Village of Tinley Park	September 27, 2011
Water Supply Contract Between Village of Oak Lawn and City of Oak Forest	April 4, 1973
Amendment to Water Supply Contract Between Village of Oak Lawn and City of Oak Forest	April 22, 1986
Term Extension Amendment to Water Supply Contract Between Village of Oak Lawn and City of Oak Forest	September 27, 2011
Water Supply Service Agreement Between Village of Oak Lawn and Village of Orland Park	October 11, 1982
Term Extension Amendment to Water Supply Contract Between Village of Oak Lawn and Village of Orland Park	September 27, 2011
INTERGOVERNMENTAL CONTRACTS—PHASE I IMPROVEMENTS	
Intergovernmental Contract Between Village of Tinley Park and Village of Oak Lawn	September 21, 1999
First Amendment to Intergovernmental Contract Between Village of Tinley Park and Village of Oak Lawn	February 20, 2001
Intergovernmental Contract Between City of Oak Forest and Village of Oak Lawn	May 22, 2001
Intergovernmental Contract Between Village of Orland Park and Village of Oak Lawn	September 20, 1999

AGREEMENT	DATE
First Amendment to Intergovernmental Contract Between Village of Orland Park and Village of Oak Lawn	April 23, 2001
Intergovernmental Contract Between Village of New Lenox and Village of Oak Lawn	September 21, 1999
First Amendment to Intergovernmental Contract Between Village of New Lenox and Village of Oak Lawn	April 20, 2001
Intergovernmental Contract Between Village of Mokena and Village of Oak Lawn	September 22, 1999
First Amendment to Intergovernmental Contract Between Village of Mokena and Village of Oak Lawn	March 26, 2001
INTERGOVERNMENTAL AGREEMENTS FOR MOKENA/NEW LENOX	
Intergovernmental Agreement Between Villages of New Lenox, Mokena and Oak Lawn In Regard to Lake Michigan Water	September 29, 1999
Term Extension Amendment to Intergovernmental Agreement Between Villages of New Lenox, Mokena and Oak Lawn In Regard to Lake Michigan Water	September 27, 2011
INTERGOVERNMENTAL AGREEMENTS FOR SOUTHWEST WATER TRANSMISSION SYSTEM IMPROVEMENTS	
Intergovernmental Agreement Between Village of Tinley Park and Village of Oak Lawn, as amended by the First Amendment to Intergovernmental Agreement (Southwest Water Transmission System Improvements)	January 24, 2006
Intergovernmental Agreement Between Village of Mokena and Village of Oak Lawn, as amended by the First Amendment to Intergovernmental Agreement (Southwest Water Transmission System Improvements)	March 28, 2006
Intergovernmental Agreement Between Village of New Lenox and Village of Oak Lawn, as amended by the First Amendment to Intergovernmental Agreement (Southwest Water Transmission System Improvements)	March 28, 2006
Intergovernmental Agreement Between Village of Orland Park and Village of Oak Lawn, as amended by the First Amendment to Intergovernmental Agreement (Southwest Water Transmission System Improvements)	March 28, 2006

EXHIBIT O

FINANCING PLAN AND PARAMETERS OAK LAWN REGIONAL WATER SYSTEM “NEW SERIES BONDS” FOR THE “2013 REGIONAL SYSTEM IMPROVEMENTS”

I. INTRODUCTION.

This Financing Plan and Parameters (the or this “*FPP*”) is set forth as Exhibit O to that certain “Regional Water System Water Sale, Purchase and Service Agreement Between the Village of Oak Lawn, Illinois and Certain of Its Municipal Customers” (the “*Agreement*”). The defined terms of the Agreement are incorporated by reference, unless otherwise defined expressly in this Exhibit O or unless the context or use of a term clearly indicates another meaning is intended. This FPP is pursuant to Section 4.B of the Agreement and relates to the New Series Bonds and Bonds issued at any time in the future to refund New Series Bonds.

II. SOURCE OF FUNDS AND LIEN PRIORITIES; PREFERENCES FOR IEPA LOANS.

The Bonds shall be payable from the “*Net Revenues*” (Regional System Revenues less Operation and Maintenance Costs). The Bonds may be in various lien positions, commonly referred to as first lien, second lien, third lien, and so on. It is anticipated that a portion of the Bonds will be issued to the IEPA pursuant to its 20-year loan program for water projects (such portion will be referred to interchangeably with Bonds as the “*IEPA Loans*”).

IEPA Loans shall be Bonds in a third lien position on Net Revenues. Oak Lawn shall procure the maximum amount of IEPA Loans made available to it to finance the Project. In stating this preference, the Parties to the Agreement acknowledge that they are familiar with the IEPA water project loan program regulations, which in general provide funding for certain Project costs and defer loan repayment for a period of time, adding the deferred interest to principal at the time the loan begins to amortize, and such amortization occurring in level stated amounts of principal and interest semi-annually for 20 years. It is possible that during the course of acquiring and constructing the 2013 Regional System Improvements (herein also the “*Project*”) the IEPA may offer a 30-year loan program. Oak Lawn will seek to issue Bonds for 30-year IEPA Loans only after Executive Consent [is] Obtained as provided in the Agreement.

One series of IEPA Loans has already been procured by Oak Lawn, utilizing its own credit on an interim basis. This is an IEPA Loan approved for \$15,000,000 (estimated to be drawn in the amount of approximately \$12,700,000), more or less, to provide for improvements at the Harker Pumping Station. This FPP permits allocation of that IEPA Loan to a Bond (*i.e.* payable from the Net Revenues). This FPP permits Oak Lawn to have allocated to it, to the fullest extent possible, the debt service payments on this IEPA Loan as its share of Capital Costs and Charges. This provision entitles Oak Lawn to the (low) interest rate obtained on such IEPA Loan.

For Bonds which must be issued which are not IEPA Loans, this FPP permits the issuance of Senior Lien Bonds with a goal of achieving a rating in the second highest rating category by one or more appropriate rating agencies (such as Moody's or S&P) which ratings are now commonly known as "AA" or "Aa." The Parties acknowledge that such ratings typically require financial covenants, such as Net Revenues coverage of debt service on such Bonds.

III. MAXIMUM PRINCIPAL AMOUNTS.

A. The maximum principal amount of Bonds issued to pay the costs of acquiring and constructing the Project, including the costs of all lands and rights in land and water, and other necessary or advisable capital expenditures related thereto, and all costs of engineering related to the Project, shall not exceed such principal amount as will produce not in excess of \$275,000,000 of proceeds.

B. To said principal amount may be added amounts as follows:

1. Costs of issuance of the New Series Bonds (which includes the costs of all Parties to the Agreement of negotiating the Agreement) including legal, financial advisory, and engineering costs of such negotiations, bank fees and underwriting fees and similar costs, costs of credit enhancement such as bond insurance, line of credit or letter of credit fees, and the like, and typical closing costs for Bonds and original issue discount.

2. Bond reserve amounts not to exceed ten percent (10%) of the face ("*par*") amount of the New Series Bonds.

3. For any series of refunding Bonds, such additional principal amounts as may be necessary to accomplish such refunding (*i.e.* pay the designated debt service [principal and interest and redemption costs, if any] of such prior series of Bonds) including costs of issuance of such refunding Bonds, in each instance limited to two percent (2%) of par plus any bank fees or credit enhancement fees related to such refunding Bonds.

4. Capitalized interest on any Bonds for a maximum term of five years.

C. The maximum principal amount of Bonds of all series, including any series of refunding Bonds, which may be outstanding at any one time shall not exceed \$297,000,000.

IV. MINIMUM PURCHASE PRICE AND COMPENSATION TO BANKS AND UNDERWRITERS.

Bonds shall be sold at not less than 98% of par, exclusive of any original issue discount. Compensation paid to any bank or financial institution acquiring Bonds in a negotiated purchase shall not exceed 1% of par. Compensation to any underwriters of Bonds shall not exceed 2% of par.

V. RATES OF INTEREST ON BONDS.

No Bond shall bear a rate of interest or have a yield greater than permitted to a non-home rule governmental unit in Illinois as currently provided in the "Bond Authorization Act" of the State, as supplemented or amended. Oak Lawn will retain an independent financial advisor for all Bonds except those which are IEPA Loans. Oak Lawn will obtain from such financial advisor an opinion on each series of Bonds except IEPA Loans that the interest rates payable and the other financial terms of such Bonds are fair and reasonable in view of the structure of such Bond issue and then current conditions in the relevant market for such Bonds.

Bonds may utilize interest rate swaps upon the terms set forth in the Bond Authorization Act.

VI. MAXIMUM ANNUAL DEBT SERVICE.

Planned maximum annual debt service shall not exceed \$22,500,000. However, Bonds may become due resulting in greater debt service than that amount with the intention of refunding such Bonds (such obligations may have what is referred to as "bullet" maturities).

VII. TERM TO MATURITY; ANNUAL DEBT SERVICE; CERTAIN BOND CONSIDERATIONS.

As noted above, the Parties acknowledge the terms upon which the IEPA Loans will be repaid.

For other Bonds, planned principal authorization, to the extent commercially reasonable, will be deferred so as to begin to amortize at the final maturity of an IEPA Loan and end prior to expiration of the current term of the Agreement.

VIII. REVOLVING LINE OF CREDIT BONDS

At any time prior to the completion of the Project, Bonds may be issued in the form of a revolving line of credit ("*L/C Bonds*") having a variable rate of interest within the maximum rate of interest set forth above. The maximum amount of such LC Bonds is \$35,000,000. If the L/C Bonds are outstanding upon completion of the Project, Oak Lawn will begin a financing effort to refund such L/C Bonds with long-term Bonds. Or, at such time, the term or maturity of the L/C Bonds may be extended to a further date if in the judgment of Oak Lawn such extension is advantageous but only after Executive Consent [is] Obtained as provided in the Agreement.

EXHIBIT P

STATEMENT OF MUTUAL COOPERATION PROCESS

For purposes of this Exhibit, all definitions as given in the Agreement of which this Exhibit is a part are incorporated by reference.

A. It is the intention of the Parties to this Agreement to create a long-term arrangement that is able to change and evolve over coming years to meet the changing demographics and needs of Oak Lawn and the Southwest System Customers.

B. Both Oak Lawn and the Southwest System Customers embrace the concept of establishing a framework for a long-term intergovernmental cooperative relationship for the reliable and cost-effective delivery of Chicago Water from Chicago to the Southwest System Customers through the Oak Lawn Regional Water System. To meet this objective, Oak Lawn and the Southwest System Customers agree to work together to investigate possible means of furthering the improvement and operation of the Oak Lawn Regional Water System to provide the Southwest System Customers with a long-term, reliable supply of Chicago Water. Oak Lawn and the Southwest System Customers agree that they will, from time to time, investigate alternative capital improvements and financing methods, as well as alternative operations and maintenance procedures, for the Oak Lawn Regional Water System, with the overall objective of enhancing the public health, safety and welfare of those to whom the Southwest System Customers provide Chicago Water.

C. Both Oak Lawn and the Southwest System Customers recognize that an essential element of this cooperative relationship is to ensure a reliable water delivery system for the provision of Chicago Water at a reasonable cost, and they jointly will seek out and develop mutually beneficial opportunities. As part of this effort, this Agreement establishes a regular method of budget development and review for the Oak Lawn Regional Water System, on Oak Lawn's annual budget cycle, and a process to evaluate budgeted items and anticipated costs.

D. Oak Lawn recognizes that the Southwest System Customers are a substantial contributor to the total Operation and Maintenance Costs of, and to the Capital Costs and Charges for, the Oak Lawn Regional Water System in the provision of Chicago Water to the Southwest System Customers, and that the Southwest System Customers desire meaningful input in various aspects of the Oak Lawn Regional Water System. Oak Lawn intends to share these enhanced input opportunities with the Southwest System Customers.

E. This Agreement will establish a variety of mechanisms for enhanced contact and communication between Oak Lawn and the Southwest System Customers on topics relevant to this Agreement including, among other things, water supply and reliability, Operation and Maintenance Costs and Capital Costs and Charges for the Oak Lawn Regional Water System, and the future effective and beneficial functioning of the Oak Lawn Regional Water System and the relationship between the Parties.

F. The mutually cooperative efforts set forth in this Exhibit will occur mainly through Working Groups as described in Sections I.B and I.D of this Exhibit and management level communications as described in the following sections. The Southwest System Customers acknowledge that providing review, feedback, recommendations and input to Oak Lawn, and Oak Lawn's acceptance of such, shall not supersede Oak Lawn's role as the sole entity responsible for the daily operation of the Oak Lawn Regional Water System. Oak Lawn supports these mutual cooperation efforts but reserves the right to accept or not accept certain recommendations provided by the Southwest System Customers.

G. The Southwest System Customers acknowledge that Oak Lawn is the licensed water system operator solely responsible for the Oak Lawn Regional Water System and as established and permitted by the IEPA, and therefore it shall be mandatory that Oak Lawn retain full operational control of the Oak Lawn Regional Water System.

H. Oak Lawn and the Southwest System Customers agree to commence mutual cooperation efforts outlined in this Exhibit, including Working Groups as described in Sections I.B and I.D of this Exhibit, upon execution of this Agreement. The Parties agree that this will enable and support the effective and efficient completion of the 2013 Regional System Improvements, the plan for which the Southwest Customers have approved.

ACCORDINGLY, OAK LAWN AND THE SOUTHWEST SYSTEM CUSTOMERS AGREE AS FOLLOWS.

I. Cooperation and Communication Regarding Reliability and Cost Control; Review and Accountability.

A. *Coordination and Communication.* Oak Lawn and the Southwest System Customers agree that they desire to establish a variety of means to enhance and promote communication and cooperation between Oak Lawn and the Southwest System Customers. In addition to those matters otherwise addressed in this Agreement, Oak Lawn and the Southwest System Customers also wish to establish procedures and processes to allow review of the Oak Lawn Regional Water System, to enable continuing channels of communication between Oak Lawn and the Southwest System Customers, and to ensure beneficial decision-making by Oak Lawn in the operation, maintenance and periodic improvement of the Oak Lawn Regional Water System. Nothing in this Exhibit is intended to require the Southwest System Customers to create reports that each does not regularly produce.

In order to enhance transparency and avoid delay in decision making, the following are the general expectations and responsibilities for communication by and between the Contractor, Oak Lawn, Customer Communities and their Consulting Engineer currently Christopher B. Burke Engineering (CBBEL), Oak Lawn's Consulting Engineer (CDM Smith), and information from public agencies or utilities involved in the Project:

Oak Lawn will receive questions and comments on the Project, conduct weekly construction and coordination meetings, update the managers and boards of trustees/city councils/village councils as needed, and process pay applications.

Oak Lawn's Consulting Engineer, currently CDM Smith, will be the central communications hub with all parties, coordinate communications with the contractor, attend weekly construction meetings, attend weekly coordination meetings with CBBEL, attend the Customer Review Committee meetings or conference calls as requested, post weekly construction coordination meeting minutes to the SharePoint site, and prepare logs of work change directives, change orders, RFI's, and submittals uploaded to the SharePoint site monthly.

Customer Communities and the Customer Communities' Consulting Engineer, currently CBBEL, will attend weekly coordination meetings, schedule and attend Customer Review Committee meetings or conference calls as needed, and update communities not on the Customer Review Committee as needed.

Change Order Working Group, at times referred to as the Customer Review Committee, will consist of three members of the customer communities that are selected by a vote of the customer communities. This group will review and approve change orders as described in section D(4). They also will update communities not on the Customer Review Committee of any decisions that are made via e-mail.

Contractor will be required to attend weekly construction meetings, respond to CDM Smith requests, and prepare minutes for weekly construction meetings.

Public Agencies and Utilities will be engaged to receive questions or comments pertaining to the project and be provided responses as required in a timely fashion.

B. Mutual Cooperation Through Working Groups.

1. Formation. To facilitate an ongoing structure for consistent communication, Oak Lawn and the Southwest System Customers agree that the Southwest System Customers will establish three working groups ("*Working Groups*"), consisting of personnel from the Southwest System Customers, to address the subject areas described in Section I.D of this Exhibit. The Southwest System Customers will notify Oak Lawn of the formation of the Working Groups and the membership of each Working Group, as well as the designated chairperson for each Working Group and such group's designated liaison to Oak Lawn, from time to time. The Southwest System Customers shall be responsible to provide staff support to the Working Groups, including preparation of meeting agenda and minutes. The Working Groups are intended to be performing jointly the role of staff of the Southwest System Customers, and are not intended to be public bodies subject to the provisions of the Open Meetings Act.

2. Oak Lawn Liaisons. Oak Lawn will designate at least one liaison to act on its behalf in cooperating with the Working Groups in various ways, including (a) meeting with the Working Groups as described in this Exhibit, (b) providing information to the Working Groups as requested by each Working Group in connection with their various subject matter areas, and (c) obtaining answers to questions and concerns raised by the Working Groups in connection with the Agreement and provision of Chicago Water to the

Southwest System Customers. Oak Lawn's liaison to each Working Group shall be a person holding a position of comparable rank and responsibilities as those held by a majority of individuals serving on each Working Group.

C. Meetings with Working Groups.

1. In General. The Southwest System Customers in conjunction with Oak Lawn will create a meeting schedule and provide an agenda for each of the Working Groups' meetings with their respective Oak Lawn liaisons from time to time. Oak Lawn and each Working Group agree that the "Operations" Working Group and the "Finance/Administration" Working Group shall each meet with their respective designated liaisons from Oak Lawn not less than two (2) times in each calendar year unless the Working Group and Oak Lawn mutually agree that fewer meetings are required from time to time. Oak Lawn and each Working Group agree that the "Management" Working Group and Oak Lawn's designated liaison will meet at least once in each calendar year, on call of the Management Working Group with at least fourteen (14) days notice to Oak Lawn. Oak Lawn and the Working Groups agree that additional meetings will be held by any of these Working Groups with their respective liaisons on call of the Working Group with at least fourteen (14) days notice to Oak Lawn. In the event of an emergency, Oak Lawn and the appropriate Working Group agree to meet as soon as is practicable under the circumstances.

2. Cooperation with Others. The Southwest System Customers acknowledge that other Municipal Customers may have substantially similar rights relating to mutual cooperation or may have an interest in the Working Group meetings or actions and agree to cooperate and coordinate with Oak Lawn to the end of avoiding duplicative efforts.

D. Working Groups. The Working Groups will be as follows:

1. Management Working Group: The Management Working Group will have at least the following functions and duties and other duties as assigned by the Southwest System Customers:

a. Review Oak Lawn's overall compliance with the terms and conditions of this Agreement;

b. Review the overall compliance of each of the Southwest System Customers with the terms and conditions of this Agreement and report on the same to Oak Lawn at least on an annual basis if requested by Oak Lawn;

c. Review and provide recommendations to Oak Lawn and the Southwest System Customers regarding any proposed revisions to, or renewals of, this Agreement;

d. Review, evaluate and provide feedback on the compliance of Oak Lawn and Chicago with the terms and conditions of the Chicago-Oak Lawn Agreement, as such matters affect the Southwest System Customers;

e. Review and provide recommendations to Oak Lawn on all purchases involving Major Capital Costs prior to approval by the corporate authorities of Oak Lawn of the contracts relating to those costs;

f. In conjunction with Oak Lawn's annual budget process, review and provide input on proposed Oak Lawn budget components for the Oak Lawn Regional Water System;

g. In conjunction with Oak Lawn's Asset Management Program for the Oak Lawn Regional Water System, review and provide input on the Oak Lawn Regional Water System's capital budget;

h. On an annual basis, provide to Oak Lawn the capital improvement plan of each Southwest System Customer for its respective Municipal Customer Water System, and provide feedback and input to Oak Lawn on said plans;

i. Review updates of the status of performance and improvements under this Agreement and the Chicago-Oak Lawn Agreement, and coordinate input and recommendations thereon from, the Operations Working Group and the Finance/Administration Working Group;

j. Provide feedback and input to Oak Lawn as well as the corporate authorities of the Southwest Customers regarding performance under this Agreement and the Chicago-Oak Lawn Agreement and matters involving the Oak Lawn Regional Water System; and

k. Make recommendations to and coordinate with Oak Lawn regarding public information and education on matters involving this Agreement through various methods and programs, such as public meetings, newsletters, websites, and social media.

l. Approve the contractor (i.e. lowest qualified bid) and any proposed engineering (design and construction) for the remaining bid packages as well as any additional proposed engineering requirements that are over \$5,000.

m. Receive and review the regional water system water loss report on an annual basis.

n. Approve the true-up of budgeted versus actual cost of the rate for the Southwest System Customers on an annual basis.

2. *Operations Working Group*: The Operations Working Group will have at least the following functions and duties and other duties as assigned by the Southwest System Customers:

- a. Review and provide feedback to Oak Lawn regarding Oak Lawn's duty to provide the supply of Chicago Water required under this Agreement;
- b. Review operational practices and procedures of Oak Lawn in the operation of the Oak Lawn Regional Water System;
- c. Review the operational practices and procedures of each of the Southwest System Customers in the operation of their respective Municipal Customer Water Systems, as such matters affect the Oak Lawn Regional Water System, and report on the same to Oak Lawn at least on an annual basis if requested by Oak Lawn;
- d. Provide input to Oak Lawn to develop appropriate methods for, and to improve, operational coordination in the operation of the Oak Lawn Regional Water System as it delivers Chicago Water to the Southwest System Customers;
- e. Review and provide recommendations to the Management Working Group and Oak Lawn on all purchases involving Major Capital Costs prior to approval by the corporate authorities of Oak Lawn of the contracts relating to those costs;
- f. In conjunction with Oak Lawn's annual budget process, review and provide input to the Finance/Administration Working Group on proposed Oak Lawn budget components for the Oak Lawn Regional Water System;
- g. In conjunction with Oak Lawn's Asset Management Program for the Oak Lawn Regional Water System, review and provide input on the capital budget for the Oak Lawn Regional Water System;
- h. Encourage continued and ongoing day-to-day communication between operators of the Oak Lawn Regional Water System and operators of the Southwest System Customers' Municipal Customer Water Systems;
- i. Review the Chicago Water use requirements of the Southwest Customers and the parameters under which such Chicago Water is to be delivered;
- j. Review the quality and source of Chicago Water provided to the Southwest System Customers under the Agreement;
- k. Review, discuss and communicate regarding potential and actual emergency conditions that may affect the delivery of Chicago Water under this Agreement;

l. Review, discuss and communicate regarding potential and actual events that may result in planned curtailment or planned shut-downs of, or other impacts on, the Chicago Water supply under this Agreement;

m. Suggest, review and provide input to Oak Lawn on cost effectiveness and cost control initiatives in areas relating to contractual services, commodities and services provided by the Oak Lawn Water Division, where such Oak Lawn Water Division provides support and services to the Oak Lawn Regional Water System; and

n. Provide input and recommendations on these matters to the Management Working Group.

3. *Finance/Administration Working Group:* The Finance/Administration Working Group will have at least the following functions and duties and other duties as assigned by the Southwest System Customers:

a. Conduct, at least on an annual basis, a review of the billing procedures, schedules, and invoices from Oak Lawn to the Southwest System Customers, including supporting documentation as requested;

b. Conduct, at least on an annual basis, a review of the components in the water rate charged by Oak Lawn to the Southwest System Customers, and any changes to or adjustments in the rate;

c. Review and communicate in regard to changes or adjustments to the Chicago Water rates;

d. Conduct, at least on an annual basis, a review of Oak Lawn's debt schedules pertaining to the Oak Lawn Regional Water System, as well as any costs allocated to the Southwest System Customers and the formulas used to calculate the Southwest System Customers' required reimbursement of such costs;

e. Review the financial impact of, and provide recommendations to, the Management Working Group on proposed financing methods, if financing is necessary, for all purchases involving Major Capital Costs prior to approval by the corporate authorities of Oak Lawn of the contracts relating to those costs and other capital items in Oak Lawn's Asset Management Program;

f. In conjunction with Oak Lawn's annual budget process, review and provide input on proposed Oak Lawn budget components for the Oak Lawn Regional Water System;

g. Suggest, review and provide input to Oak Lawn on cost effectiveness and cost control initiatives in areas relating to contractual services,

commodities and services provided by the Oak Lawn Water Division, where such Division provides support and services to the Oak Lawn Regional Water System;

h. Review the financial impact of the use of the Oak Lawn Regional Water System by Municipal Customers other than the Southwest System Customers who are Parties under this Agreement, and costs assigned to such Municipal Customers, including any amounts such other customers may be required to pay as a fair share, equitable contribution based on the terms of this Agreement; and

i. Provide input and recommendations on these matters and proposed System Projects to the Management Working Group.

4. *Change Order Working Group*: The Change Order Working Group will be provided with bid package change orders that exceed \$20,000 in construction cost per occurrence to review and approve or reject. The Change Order Working Group, Oak Lawn's Consulting Engineer, and Oak Lawn will have at least the following functions and duties:

a. Oak Lawn's Consulting Engineer:

- i. Determine if a change order meets the qualifications for review by the Change Order Working Group and Oak Lawn.
- ii. Change Order Working Group, Customer Communities' Consulting Engineer & Oak Lawn will discuss all change orders at weekly coordination meetings.
- iii. If the change order qualifies for review by the Change Order Working Group, then Oak Lawn's Consulting Engineer will provide that change order to them for review.
- iv. If the change order is approved by the Change Order Working Group, Oak Lawn's Consulting Engineer will issue a Work Change Directive to the Contractor or issue a change order to the Contractor which may be comprised of several approved Work Change Directives.
- v. If the change order is not approved then Oak Lawn's Consulting Engineer, the Change Order Working Group, and Oak Lawn will review the recommendations of both consulting engineers, arrange the necessary meeting to determine the solution, if possible, and issue the appropriate direction to the Contractor.

- b. Change Order Working Group, Customer Communities' Consulting Engineer & Oak Lawn:
 - i. Timely review change order requests
 - ii. Attend meetings or conference calls to address and review recommendations of the consulting engineers
 - iii. Issue decisions on whether change orders requiring Change Order Working Group approval are approved or not approved within three (3) business days from receipt by Oak Lawn's Consulting Engineer in writing.

II. Notice of Oak Lawn Meetings. Oak Lawn shall provide notice to the Southwest System Customers of any meeting of the Oak Lawn corporate authorities, or any board, committee, commission, advisory group or other similar body of Oak Lawn when Oak Lawn anticipates that the agenda for a meeting of any such body will include matters relating to the Oak Lawn Regional Water System. Such notice to the Southwest System Customers shall be given to the Southwest System Customers at the same time as notice is given to the members of any such body and shall include copies of the agenda and any agenda materials provided to such body. The Southwest System Customers shall be responsible, not less often than annually, to provide an email address for such notifications, and sending to such addresses shall be adequate notice.

III. Audited Financial Statements. Oak Lawn shall provide to the Southwest System Customers, within two hundred ten (210) days after the close of each of its Fiscal Year, an audit of the Oak Lawn Regional Water System financial records prepared by a certified public accounting firm retained by Oak Lawn for such Fiscal Year.

EXHIBIT Q
AGGREGATE COSTS TEMPLATE

**Exhibit Q
Aggregate Costs Template**

Cost Component	Municipal Customer	Chicago Ridge	Country Club Hills	Matteson	Oak Lawn	Olympia Fields	Palos Hills	Palos Park
Operation and Maintenance Costs								
Chicago Water		\$3.317	\$3.317	\$3.317	\$3.317	\$3.317	\$3.317	\$3.317
Electricity Costs		0.020	0.099	0.138	0.054	0.101	0.020	0.037
Pump Station Maintenance Costs		0.046	0.081	0.055	0.011	0.162	0.042	0.131
Transmission Main Maintenance Costs		0.013	0.079	0.058	0.003	0.179	0.055	0.170
System Operations Costs		0.092	0.092	0.092	0.092	0.092	0.092	0.092
Sub-Total		\$3.488	\$3.668	\$3.660	\$3.477	\$3.851	\$3.526	\$3.747
Other Non-Operating Charges								
Operation and Maintenance Reserve		\$0.080	\$0.080	\$0.080	\$0.080	\$0.080	\$0.080	\$0.080
Equitable Return		0.050	0.050	0.050	0.050	0.050	0.050	0.050
Insurance Reserves		0.000	0.000	0.000	0.000	0.000	0.000	0.000
Rate Covenant/ Coverage Charges		0.000	0.000	0.000	0.000	0.000	0.000	0.000
Renewal, Repair and Replacement Reserve		0.064	0.064	0.064	0.064	0.064	0.064	0.064
Total ⁽¹⁾		\$3.682	\$3.862	\$3.854	\$3.671	\$4.045	\$3.720	\$3.941
Capital Costs and Charges								
Bond Principal & Interest		\$1,492.00	\$9,790.00	\$21,945.00	\$25,846.00	\$6,189.00	\$12,431.00	\$4,901.00
Swap Payments		0.00	0.00	0.00	0.00	0.00	0.00	0.00
Bond Insurance, LOC fees, etc.		0.00	0.00	0.00	0.00	0.00	0.00	0.00
Costs of Issuance		0.00	0.00	0.00	0.00	0.00	0.00	0.00
Bond Debt Service Reserves		0.00	0.00	0.00	0.00	0.00	0.00	0.00
Default Costs Allocable to Bonds		0.00	0.00	0.00	0.00	0.00	0.00	0.00
Total ⁽¹⁾		\$1,492.00	\$9,790.00	\$21,945.00	\$25,846.00	\$6,189.00	\$12,431.00	\$4,901.00
Default Costs								
Default Costs		\$0.00	\$0.00	\$0.00	\$0.00	\$0.00	\$0.00	\$0.00
Total ⁽¹⁾		\$0.00	\$0.00	\$0.00	\$0.00	\$0.00	\$0.00	\$0.00

Cost Component	Municipal Customer	Oak Forest	Orland Park	Tinley Park (ALL)	Tinley Park (ONLY)	Mokena	New Lenox	Orland Hills (IAW) ⁽²⁾
Operation and Maintenance Costs								
Chicago Water		\$3.317	\$3.317	\$3.317	\$3.317	\$3.317	\$3.317	\$3.317
Electricity Costs		0.057	0.066	0.112	0.112	0.112	0.112	0.112
Pump Station Maintenance Costs		0.026	0.009	0.009	0.010	0.009	0.009	0.009
Transmission Main Maintenance Costs		0.033	0.013	0.009	0.009	0.009	0.009	0.009
System Operations Costs		0.092	0.092	0.092	0.092	0.092	0.092	0.092
Sub-Total		\$3.525	\$3.497	\$3.539	\$3.540	\$3.539	\$3.539	\$3.539
Other Non-Operating Charges								
Operation and Maintenance Reserve		\$0.080	\$0.080	\$0.080	\$0.080	\$0.080	\$0.080	\$0.080
Equitable Return		0.050	0.050	0.050	0.050	0.050	0.050	0.050
Insurance Reserves		0.000	0.000	0.000	0.000	0.000	0.000	0.000
Rate Covenant/ Coverage Charges		0.000	0.000	0.000	0.000	0.000	0.000	0.000
Renewal, Repair and Replacement Reserve		0.064	0.064	0.064	0.064	0.064	0.064	0.064
Total ⁽¹⁾		\$3.719	\$3.691	\$3.733	\$3.733	\$3.733	\$3.733	\$3.733
Capital Costs and Charges								
Bond Principal & Interest		\$17,124.00	\$58,347.00	\$100,694.00	\$52,832.00	\$17,654.00	\$30,208.00	N/A
Swap Payments		0.00	0.00	0.00	0.00	0.00	0.00	0.00
Bond Insurance, LOC fees, etc.		0.00	0.00	0.00	0.00	0.00	0.00	0.00
Costs of Issuance		0.00	0.00	0.00	0.00	0.00	0.00	0.00
Bond Debt Service Reserves		0.00	0.00	0.00	0.00	0.00	0.00	0.00
Default Costs Allocable to Bonds		0.00	0.00	0.00	0.00	0.00	0.00	0.00
Total ⁽¹⁾		\$17,124.00	\$58,347.00	\$100,694.00	\$52,832.00	\$17,654.00	\$30,208.00	\$0.00
Default Costs								
Default Costs		\$0.00	\$0.00	\$0.00	\$0.00	\$0.00	\$0.00	\$0.00
Total ⁽¹⁾		\$0.00	\$0.00	\$0.00	\$0.00	\$0.00	\$0.00	\$0.00

⁽¹⁾ Totals may not sum due to rounding.

⁽²⁾ Capital Costs for Orland Hills (Illinois American Water) are included in those of Tinley Park.

EXHIBIT R
BUDGET TEMPLATE

Title	YR	Dept Acct	VOL %	Amount	Outside %	REGIONAL				RETAIL				GENERAL FUND					
						8120-8120	8120-8120	8120-8135	8120-8140	8120-8120	8120-8130	8120-8135	8120-8140	8130-8120	8130-8130	8130-8135	8130-8140	8130-8120	8130-8130
Engineer	105,816.90	8120	80.00%	84,653.52	20.00%	21,163.38	-	-	-	-	-	-	-	-	-	-	-	-	105,816.90
Budget Director	100,294.20	8120	80.00%	80,235.36	15.00%	15,044.13	-	-	-	-	-	-	-	-	-	-	-	-	100,294.20
Division Manager	97,059.30	8120	80.00%	77,647.44	20.00%	19,411.86	-	-	-	-	-	-	-	-	-	-	-	-	97,059.30
Accounting Clerk	58,536.00	8120	75.00%	43,902.00	25.00%	14,634.00	-	-	-	-	-	-	-	-	-	-	-	-	58,536.00
Account Clerk II	55,845.50	8120	100.00%	55,845.50	0.00%	-	-	-	-	-	-	-	-	-	-	-	-	-	55,845.50
Account Clerk II	54,168.00	8120	90.00%	48,751.20	10.00%	5,416.80	-	-	-	-	-	-	-	-	-	-	-	-	54,168.00
Crew Chief	91,416.00	8130 & 8135	100.00%	-	100.00%	91,416.00	-	-	-	-	-	-	-	-	-	-	-	-	91,416.00
Water Plant Operator	91,425.90	8130 & 8135	100.00%	91,425.90	0.00%	-	-	-	-	-	-	-	-	-	-	-	-	-	91,425.90
Water Plant Operator	77,832.00	8130 & 8135	0.00%	-	100.00%	-	-	-	-	-	-	-	-	-	-	-	-	-	77,832.00
Water Plant Operator	77,832.00	8130 & 8135	0.00%	-	100.00%	-	-	-	-	-	-	-	-	-	-	-	-	-	77,832.00
Water Plant Operator	79,392.00	8130 & 8135	50.00%	38,916.00	50.00%	38,916.00	-	-	-	-	-	-	-	-	-	-	-	-	79,392.00
Maintenance Worker	47,363.00	8135-4500	100.00%	47,363.00	0.00%	-	-	-	-	-	-	-	-	-	-	-	-	-	47,363.00
Equipment Operator	69,720.00	8135-4400	100.00%	69,720.00	0.00%	-	-	-	-	-	-	-	-	-	-	-	-	-	69,720.00
Equipment Operator	60,728.00	8135-4400	100.00%	60,728.00	0.00%	-	-	-	-	-	-	-	-	-	-	-	-	-	60,728.00
Maintenance Worker	54,768.00	8135-4500	100.00%	54,768.00	0.00%	-	-	-	-	-	-	-	-	-	-	-	-	-	54,768.00
Maintenance Worker	55,928.00	8135-4500	100.00%	55,928.00	0.00%	-	-	-	-	-	-	-	-	-	-	-	-	-	55,928.00
Maintenance Worker	53,718.00	8135-4500	100.00%	53,718.00	0.00%	-	-	-	-	-	-	-	-	-	-	-	-	-	53,718.00
Maintenance Worker	54,576.00	8135-4500	100.00%	54,576.00	0.00%	-	-	-	-	-	-	-	-	-	-	-	-	-	54,576.00
Maintenance Worker	63,228.00	8135-4500	100.00%	63,228.00	0.00%	-	-	-	-	-	-	-	-	-	-	-	-	-	63,228.00
Maintenance Worker	44,607.00	8135-4500	100.00%	44,607.00	0.00%	-	-	-	-	-	-	-	-	-	-	-	-	-	44,607.00
Water/Sewer Inspector	75,120.00	8140-43900	100.00%	75,120.00	0.00%	-	-	-	-	-	-	-	-	-	-	-	-	-	75,120.00
Water/Sewer Inspector	76,632.00	8140-43900	100.00%	76,632.00	0.00%	-	-	-	-	-	-	-	-	-	-	-	-	-	76,632.00
Water/Sewer Inspector	75,876.00	8140-43900	100.00%	75,876.00	0.00%	-	-	-	-	-	-	-	-	-	-	-	-	-	75,876.00
Subtotal	1,699,713.80			1,128,448.04		401,362.17	226,146.14	85,018.95	599,654.95	227,628.00	75,670.17	162,846.00	162,846.00	1,519,810.21	169,903.59	401,362.17	1,699,713.80		
Motor Reader	4,477.68	8140-48800	100.00%	4,477.68	0.00%	-	-	-	-	-	-	-	-	-	-	-	-	-	4,477.68
Motor Reader	12,455.28	8140-48800	100.00%	12,455.28	0.00%	-	-	-	-	-	-	-	-	-	-	-	-	-	12,455.28
Motor Reader	5,795.82	8140-48800	100.00%	5,795.82	0.00%	-	-	-	-	-	-	-	-	-	-	-	-	-	5,795.82
Motor Reader	5,765.58	8140-48800	100.00%	5,765.58	0.00%	-	-	-	-	-	-	-	-	-	-	-	-	-	5,765.58
Motor Reader	9,505.64	8140-48800	100.00%	9,505.64	0.00%	-	-	-	-	-	-	-	-	-	-	-	-	-	9,505.64
Subtotal	38,000.00			38,000.00		-	-	-	-	-	-	-	-	-	-	-	-	-	38,000.00
Total Employees	1,737,713.60			1,166,448.04		401,362.17	226,146.14	85,018.95	599,654.95	227,628.00	75,670.17	162,846.00	162,846.00	1,519,810.21	169,903.59	401,362.17	1,737,713.60		

STATE OF ILLINOIS)
COUNTY OF COOK) SS
COUNTY OF WILL)

CERTIFICATE

I, KRISTIN A. THIRION, Village Clerk of the Village of Tinley Park, Counties of Cook and Will and State of Illinois, DO HEREBY CERTIFY that the foregoing is a true and correct copy of Ordinance No. 2020-O-066, “AN ORDINANCE OF THE VILLAGE OF TINLEY PARK, COOK AND WILL COUNTIES, ILLINOIS, AMENDING CERTAIN PROVISIONS OF THE LONG TERM WATER SALE, PURCHASE AND SERVICE AGREEMENT BY AND AMONG THE VILLAGE OF OAK LAWN, COOK COUNTY, ILLINOIS, AND OTHER MUNICIPALITIES, AND AUTHORIZING THE EXECUTION AND DELIVERY OF SAID AMENDMENT,” which was adopted by the President and Board of Trustees of the Village of Tinley Park on October 20, 2020.

IN WITNESS WHEREOF, I have hereunto set my hand and affixed the corporate seal of the Village of Tinley Park this 20th day of October, 2020.

KRISTIN A. THIRION, VILLAGE CLERK